

Quinelato
instrumentos cirúrgicos

Bucomaxilofacial

Catálogo de Produtos



Catálogos Quinelato

Para ajudar na escolha de seus instrumentos, a Quinelato disponibiliza uma série de *Catálogos em várias especialidades*. São edições norteadas pelas disciplinas oferecidas nas principais universidades e cursos de especialização do país.

Cirurgia
Dentística
Ortodontia
Periodontia
Implantodontia
Bucomaxilofacial



www.quinelato.com.br

[f](#) [i](#) [@](#)quinelatoqualidade

Acesse também as versões digitais de nossos catálogos:



HISTÓRIA EXPERIÊNCIA SEGURANÇA CONFIANÇA

A Quinelato é uma marca fortemente conhecida no Brasil e em vários outros países pelo seu arsenal de instrumentos cirúrgicos e odontológicos.

São 75 anos produzindo o melhor em termos de qualidade e garantia, em parceria com grandes profissionais do setor.

Os instrumentos Quinelato são produzidos, testados e aprovados dentro de rígidos padrões de industrialização, assegurando aos profissionais e instituições muito mais segurança e eficiência em seus procedimentos.



Abaixa-língua & Abre-boca	Tongue depressor & Mounth gag Bajalengua & Abreboca	5
Afastadores	Retractors Separadores	6
Alavancas e elevadores	Elevators Elevadores	14
Cabos de bisturi	Scalpel Handles Mangos de Bisturi	17
Cânulas	Suction Tubes Tubos de Aspiración	18
Cinzéis	Chisels Cinceles	19
Curetas	Curettes	24
Descoladores	Dissectors	26
Goivas	Gouges	17
Limas, Raspas e Ruginas	Bone files and Nasal Rasps Limas para Huesos y Escofinas Nasales	23
Material de Apoio	Miscellaneous Varios	43
Osteótomos	Osteotomes	19
Pinças Anatômicas	Anatomic Forceps Pinzas Anatómicas	28
Pinças Diversas	Forceps Pinzas	33
Pinças Hemostáticas	Hemostatic Forceps Pinzas Hemostáticas	31
Pinças p/ Ossos	Bone Forceps Pinzas para huesos	36
Porta-agulhas	Needle Holders Porta Agujas	38
Redução & Trauma	Reduction & Trauma Reducción & Trauma	37
Tesouras	Scissors Tijeras	40



Abaixa-língua & Abre-boca

Tongue depressor & Mounth gag | Bajalengua & Abreboca



BRUENINGS
QX.385.19



WIEDER
QD.195.00



STERNBERG (par)
QD.105.00

Afastadores

Retractors | Separadores

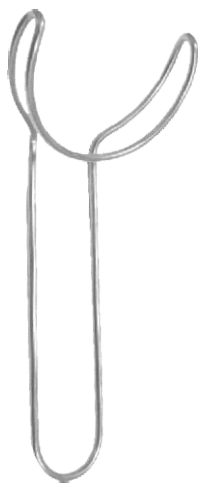

BRANEMARK
QD.105.50

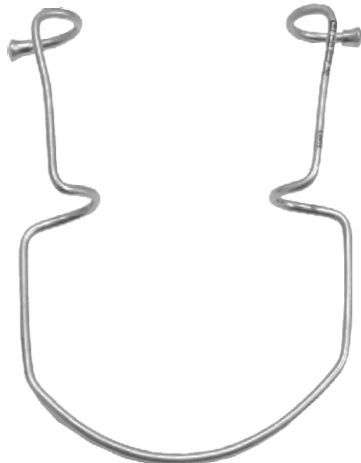

ORINGER
QD.937.00



ÓRBITA
QD.696.00



SHUMAN
QD.938.00



MINNESOTA
QD.150.14



**MINNESOTA
C/ASPIRADOR**
QD.152.14



**MINNESOTA
CAWOOD**
QD.153.00



**MINNESOTA
SVERZUT**
QD.153.10

Afastadores

Retractors | Separadores



MEAD
 QD.160.10



FARABEUF (PAR)

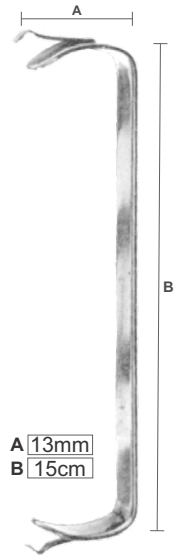

FARABEUF MODIFICADO
 QG.660.15



OBWEGESER
 P/ MENTO
 QD.250.17



OBWEGESER
 P/ PROGENISMO
 QD.250.18



OBWEGESER
 MODIFICADO
 QD.254.00

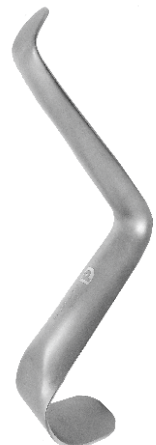

OBWEGESER
 MINI Nº 1
 QD.255.00

Afastadores

Retractors | Separadores



Medidas em mm

QD.251.40
A: 40 B: 30

OBWEGESER



Medidas em mm

QD.251.65
A: 11 B: 65

QD.251.80

A: 11 B: 80

**OBWEGESER
P/ RAMO**



Medidas em mm

QD.256.12
A: 12 B: 30

**OBWEGESER
P/ RAMO**



Medidas em mm

QD.253.00
A: 7 B: 30

QD.253.42

A: 11 B: 42

QD.253.62

A: 11 B: 62

**OBWEGESER
P/ CIMA**



Medidas em mm

QD.252.00
A: 7 B: 30

QD.252.42

A: 11 B: 42

QD.252.62

A: 11 B: 62

**OBWEGESER
P/ BAIXO**

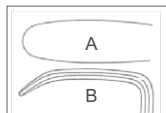

Medidas em mm

Código	Nº	A	B
QG.291.01	1	11 X 30	
QG.291.02	2	14 X 30	
QG.291.03	3	16 X 30	

LANGENBECK | 21 cm



Código	Ponta
QG.095.10	10mm
QG.095.17	17mm
QG.095.20	20mm
QG.095.22	22mm

MINI LANGENBECK | 13,5 cm

Afastadores

Retractors | Separadores

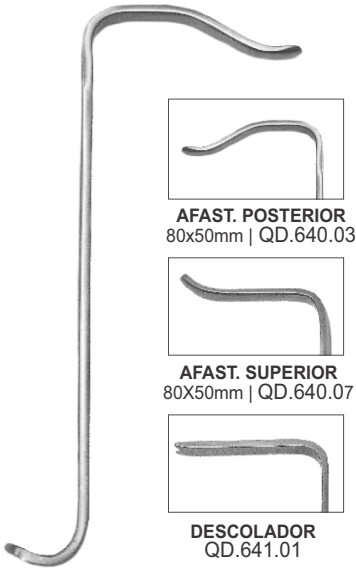

AFASTADOR & DESCOLADOR DE CÔNDILO DUNN DAUTREY

AFASTADOR P/ ATM



LOCALIZADOR DE NERVO
Nº 1 | QD.802.01



AFASTADOR P/ CAMPO CIRÚRGICO DE ATM
QG.716.15



AFASTADOR FARABEUF P/ ATM
QG.662.14



AFASTADORES ANTERIOR & POSTERIOR
QD.650.01

ANTERIOR
QD.650.02

Afastadores

Retractors | Separadores

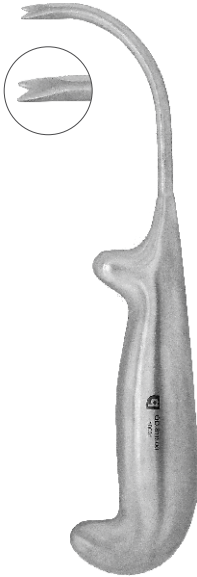

**POSICIONADOR
CONDILAR**
QD.810.00



**GANCHO
TESSIER**
QD.717.00

Quinelato
instrumentos cirúrgicos

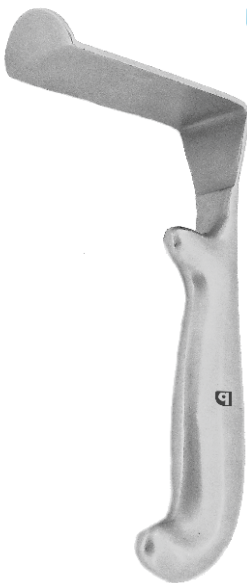

**AFASTADOR DE BASE
MANDIBULAR LARGO**
QD.718.02



HARGIS
QD.639.00

Afastadores

Retractors | Separadores



BAUER



SAGITAL ESQUERDO
9mm | QD.936.01



SAGITAL DIREITO
9mm | QD.936.02



LAVASSIER
QD.188.01

Afastadores

Retractors | Separadores

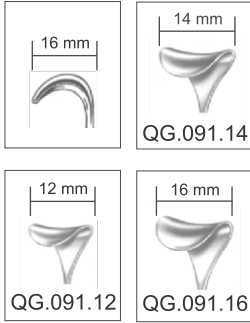

DESMAREST
16 cm

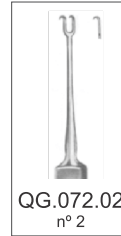
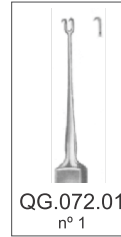

GUTHRIE
16 cm



SENN-MULLER
16 cm

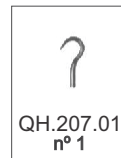

GILLIES
18 cm



Afastadores

Retractors | Separadores

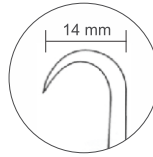

AGUDO

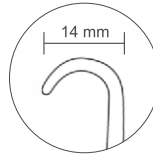

ROMBO



QG.220.01

QG.221.01



QG.220.02

QG.221.02



QG.220.03

QG.221.03

AFASADOR VOLKMAN



QX.238.01

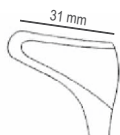

QX.238.02

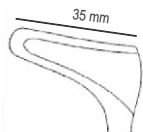

QX.238.03



ESPÉCULO HARTMANN

Alavancas & Elevadores

Elevators | Elevadores



Alavancas Apexo

Apexo elevators | Elevadores



APEXO Nº 301
QD.415.21



APEXO Nº 302
QD.415.22



APEXO Nº 303
QD.415.23

Quinelato
instrumentos cirúrgicos



Alavancas Apical

Apical elevators | Elevadores



APICAL Nº 301
QD.401.21



APICAL Nº 302
QD.401.22



APICAL Nº 303
QD.401.23



APICAL Nº 304
QD.401.24



APICAL Nº 305
QD.401.25

Alavancas & Elevadores

Elevators | Elevadores



Alavancas Heidbrink

Heidbrink elevators | Elevadores



HEIDBRINK Nº 1
QD.435.41

HEIDBRINK INFANTIL
Nº 1 | QD.435.51



HEIDBRINK Nº 2
QD.435.42

HEIDBRINK INFANTIL
Nº 2 | QD.435.52



HEIDBRINK Nº 3
QD.435.43

HEIDBRINK INFANTIL
Nº 3 | QD.435.53



Alavancas Seldin

Seldin elevators | Elevadores



SELDIN 1L
QD.405.20



SELDIN 1R
QD.405.21



SELDIN 2
QD.405.22



SELDIN
INFANTIL 1L
QD.405.24



SELDIN
INFANTIL 1R
QD.405.25



SELDIN
INFANTIL 2
QD.405.26



Alavancas Potts

Potts elevators | Elevadores



POTTS DIREITA | QD.470.01



POTTS ESQUERDA | QD.470.02

quinelato
instrumentos cirúrgicos

Cabos de Bisturi

Scalpel Handles | Mangos de Bisturi



Nº 3
12,8 cm
QA.110.03



Nº 7
16,5 cm
QA.110.07



Nº 5A
14,5 cm
QA.111.05



Nº 3L
12,8 cm
QA.111.03

Cânulas de Sucção

Suction Tubes | Tubos de Aspiración



QN.763.19

Ø 3mm | 19cm

QN.763.22

Ø 4mm | 22cm



QN.765.30

QN.765.10

Ø 3,0 mm

Ø 1,0 mm

QN.765.33

QN.765.15

Ø 3,5 mm

Ø 1,5 mm

QN.765.40

QN.765.20

Ø 4,0 mm

Ø 2,0 mm

QN.765.50

QN.765.27

Ø 5,0 mm

Ø 2,5 mm

FRAZIER P/ BMF

FRAZIER ANGULADA
20 cm



Curva

QH.211.00

Ø8mm | 21cm



Reta

QH.210.00

Ø10mm | 21cm



POOLE



QH.807.00

Ø 8mm | 30cm

YANKAUER

Cinzéis, Gauges & Osteótomos

Chisels, Gauges & Osteotomes | Cinceles, Osteótomos

Oral & maxillofacial surgery
Cirugía oral y maxilofacial

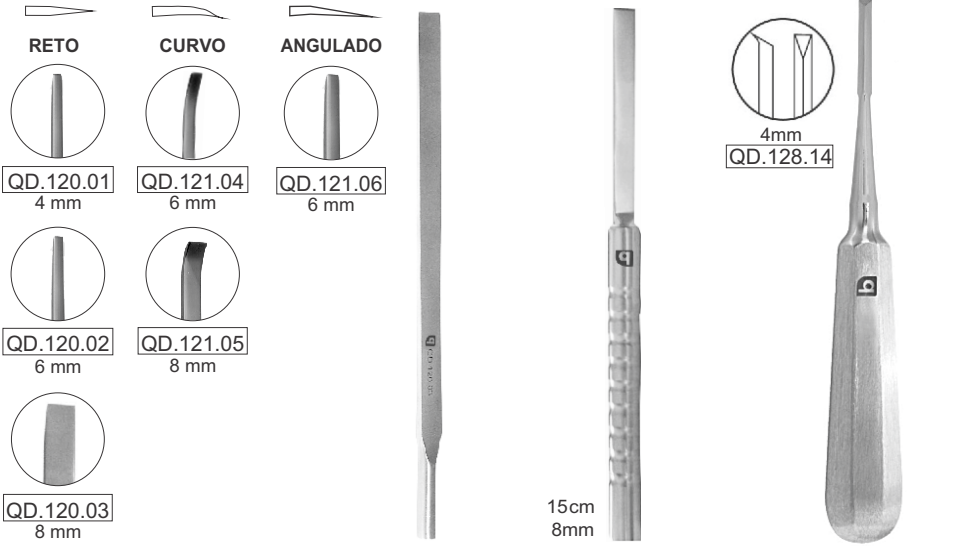

WAGNER

WAGNER ROBUSTO
QD.120.04

GARDNER

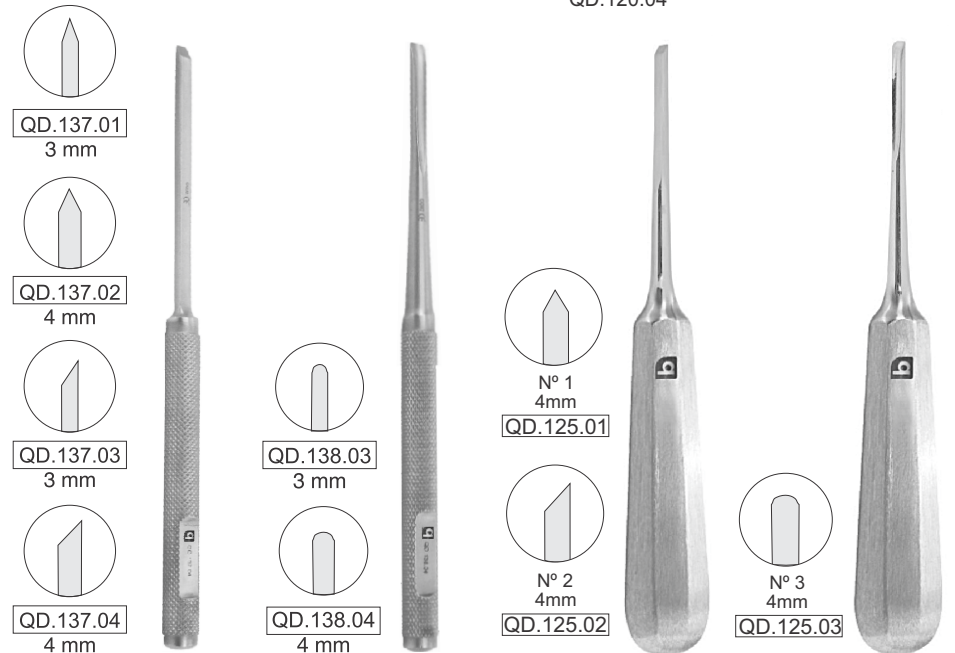

LUCAS
16 cm

LUCAS
16 cm
(Goiva)

ALEXANDER

ALEXANDER
(Goiva)

Cinzéis, Goivas & Osteótomos

Chisels, Gouges & Osteotomes | Cinceles & Osteótomos



**DESJUNÇÃO PALATINA
SVERZUT**
QD.197.00

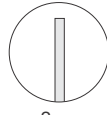

2mm
QX.225.02

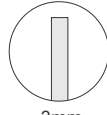

3mm
QX.225.03

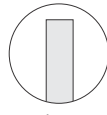

4mm
QX.225.04



WEST
16 cm



Ponta
Oliva



WAGNER P/ SEPTO NASAL
QD.122.18



**CINZEL ESPÁTULA
CURVO**
QD.116.01



**CINZEL ESPÁTULA
RETO**
QD.116.02

6mm
QX.308.06

8mm
QX.308.08



PONTA EM V

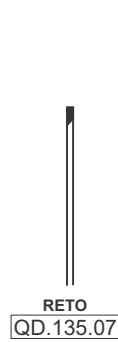

RETO
QD.135.07



ANGULADO
QD.135.57



COM STOP
14,5 cm

Cinzeis, Goivas & Osteótomos

Chisels, Gauges & Osteotomes | Cinceles, Osteótomos

Oral & maxillofacial surgery
Cirugia oral y maxilofacial

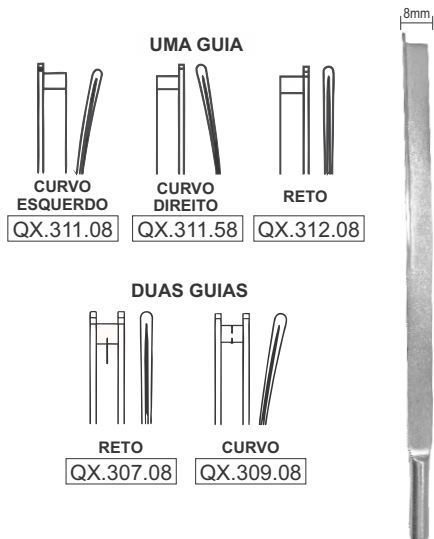

COM GUIA DELICADO

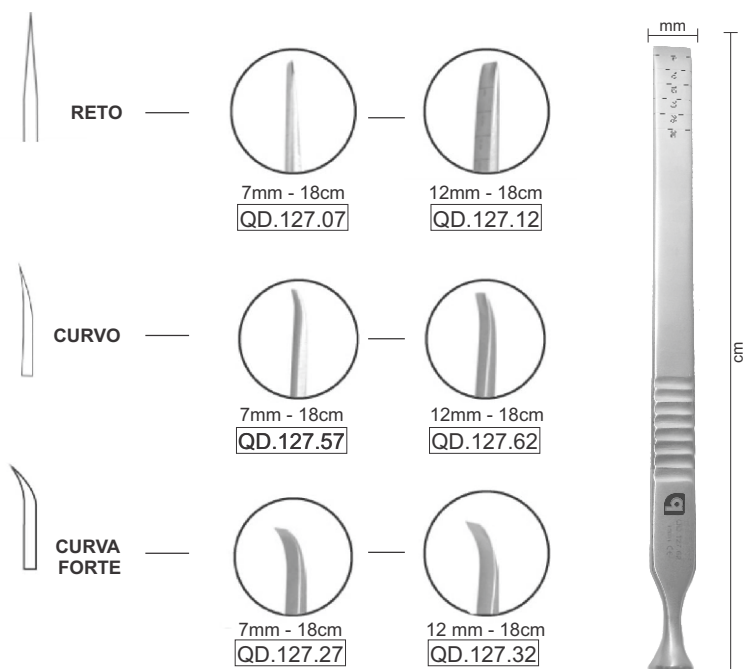

MARCA PROFUNDIDADE

Osteótomos Lexer

Lexer Osteotomes



23,5cm

08 mm	QO.240.08
10 mm	QO.240.10
12 mm	QO.240.12

Cabo em Celeron

LEXER RETO



18,5 cm



04 mm	QO.242.04
06 mm	QO.242.06
08 mm	QO.242.08
10 mm	QO.242.10
12 mm	QO.242.12

Cabo em Celeron

MINI LEXER RETO

Limas, Raspas & Ruginas

Bone files and Nasal Rasps | Limas para Huesos y Escofinas Nasales

Limas p/ Osso Miller

Miller Bone Files | Limas para Huesos Miller



Nº 1 | QD.590.01



Nº 2 | QD.590.02



Nº 3 | QD.590.03

Limas Seldin

Seldin Bone Files | Limas para Huesos Seldin



Nº 1 (12) | QD.660.01



Nº 2 (11) | QD.021.20



RASPA P/ OSSO
MÉDIA | QD.660.02 GRANDE | QD.660.03



RUGINA FARABEUFF | 15 cm
RETA | QO.292.15 CURVA | QO.293.15





SERRILHADA
QD.009.84



Nº 84
QD.008.84



Nº 85
QD.008.85



Nº 86
QD.008.86



Nº 87
QD.008.87

Curetas

Curettes

Volkman

Volkman Curette | Cureta Volkman

N° 000
3,6mm
QO.296.01

N° 00
4,4mm
QO.296.02

N° 0
5,2mm
QO.296.03

N° 2
8,5mm
QO.296.05

N° 4
11,5mm
QO.296.07

Pontas: escala 1/1



17cm

Descoladores

Dissectors | Descoladores



FREER
QX.546.18



HURD
QX.281.22



PALATAL
QX.545.18



EM J
QD.194.20



RAMO SVERZUT
QD.190.20



HENAHAN
QD.191.18



ELEVADOR SELDIN
N° 23
QD.313.23

Descoladores

Dissectors | Descoladores Molt



DUPLO | RETO BUSER
QD.935.02



DESCOLADOR DE MOLT Nº 9
QD.935.18



DESCOLADOR DE MOLT DELICADO Nº 9
QD.935.09

*20% menor
que o padrão



CURETA DE MOLT 2-4
QD.934.15



DESCOLADOR DE RAMO + MOLT
QD.680.00

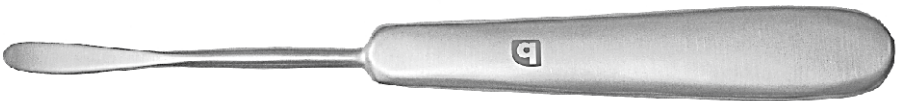

DESCOLADOR DE MOLT C/ CABO
PONTA PEQUENA | QD.935.20 PONTA GRANDE | QD.935.22

quinelato
instrumentos cirúrgicos

Pinças Anatômicas

Anatomic Forceps | Pinzas Anatómicas

ADSON

*Adson | Micro Adson: 12 cm



**ADSON
C/ SERRILHA**
QC.168.12



**ADSON
C/ WIDIA**
QW.168.12



**ADSON
C/ ATRAUMA**
QC.364.12



**ADSON
C/ DENTE**
QC.368.12



**MICRO ADSON
C/ SERRILHA**
QC.404.12

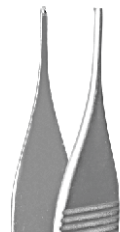

**MICRO ADSON
C/ DENTE**
QC.406.12

Pinças Anatômicas

Anatomic Forceps | Pinzas Anatómicas

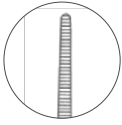

**RETA
 C/ SERRILHA**

QC.174.17

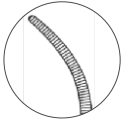

**CURVA
 C/ SERRILHA**

QC.175.17

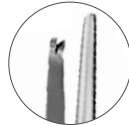

12 cm	QC.301.12
14 cm	QC.301.14
16 cm	QC.301.16
18 cm	QC.301.18



12 cm	QC.100.12
14 cm	QC.100.14
16 cm	QC.100.16
18 cm	QC.100.18



CUSHING | 17 cm

DENTE DE RATO

DISSECÇÃO



14 cm	QZ.110.14
16 cm	QZ.110.16
18 cm	QZ.110.18



DIETRICH

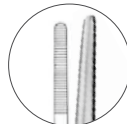

QX.391.14



LUCAE | 14 cm



GILLIES
 16 cm | QD.650.16

Pinças Anatômicas

Anatomic Forceps | Pinças Anatômicas

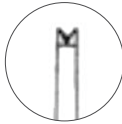

RETA C/ DENTE

QC.386.18

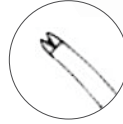

CURVA C/ DENTE

QC.387.18

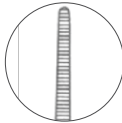

RETA C/ SERRILHA

QC.186.18

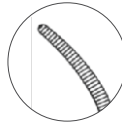

CURVA C/ SERRILHA

QC.187.18

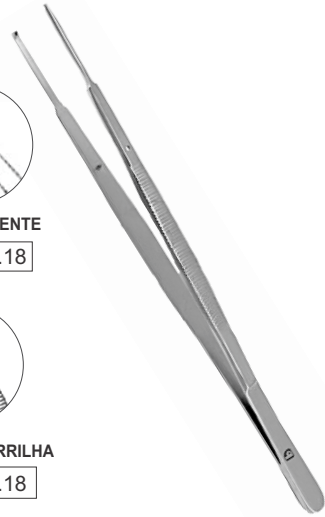

GERALD | 18 cm

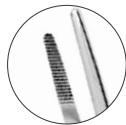

SERRILHA

18 cm | QZ.120.18

20 cm | QZ.120.20

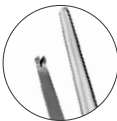

DENTE DE RATO

18 cm | QZ.130.18

20 cm | QZ.130.20



WIDIA

18 cm | QW.120.18

20 cm | QW.120.20



POTTS-SMITH

Pinças Hemostáticas

Hemostatic Forceps | Pinzas Hemostáticas

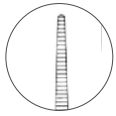

RETA
QF.306.10

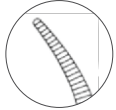

CURVA
QF.307.10

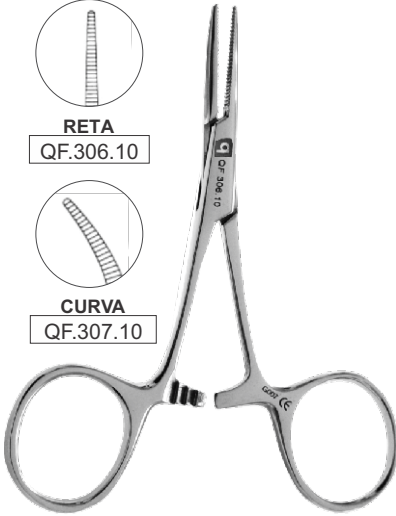

HALSTEAD-HARTMANN | 10 cm

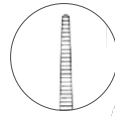

RETA
QF.310.12

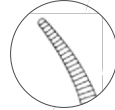

CURVA
QF.311.12

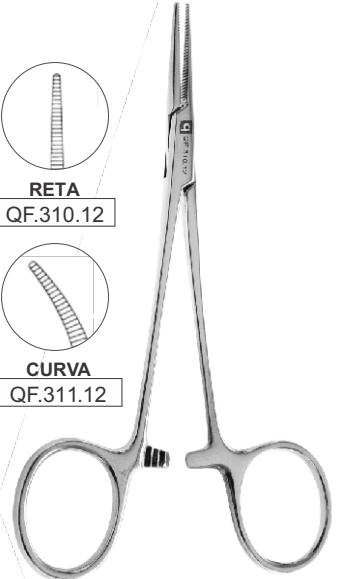

HALSTEAD-MOSQUITO | 12,5 cm

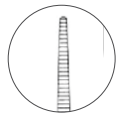

RETA
QF.320.12

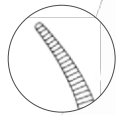

CURVA
QF.321.12

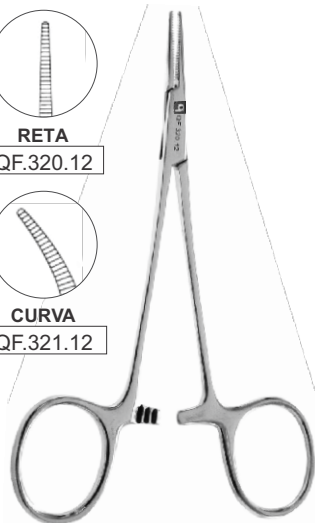

MICRO-MOSQUITO | 12 cm

Pinças Hemostáticas

Hemostatic Forceps | Pinças Hemostáticas

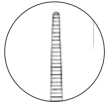

RETA

14 cm	QF.340.14
16 cm	QF.340.16



CURVA

14 cm	QF.341.14
16 cm	QF.341.16



CRILE

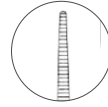

RETA

14 cm	QF.330.14
16 cm	QF.330.16



CURVA

14 cm	QF.331.14
16 cm	QF.331.16

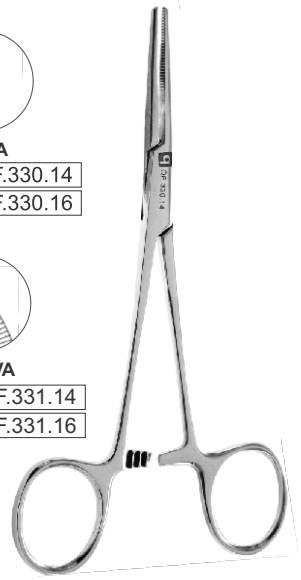

KELLY



17 cm	QF.479.17
20 cm	QF.479.20



MIXTER



14 cm	QF.176.14
16 cm	QF.176.16



PEAN-MURPHY

Pinças Diversas

Forceps | Pinzas



ALLIS | 5x6 dentes | 15 cm
 QL.134.15

ALLIS MODIFICADA
 QL.134.00

BACKHAUS

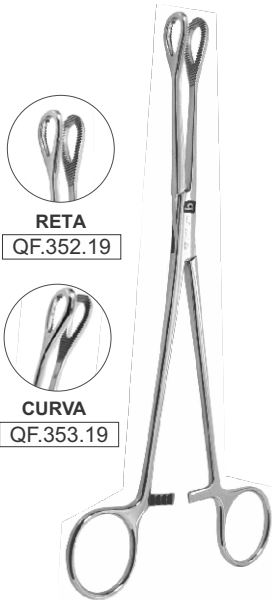

RETA
 QF.352.19

CURVA
 QF.353.19

FOERSTER
 C/ serrilha | 19 cm



COLLIN OVAL | 19 cm
 QF.270.19

Pinças Diversas

Forceps | Pinzas



HARTMANN NASAL | 16 cm
QX.141.16

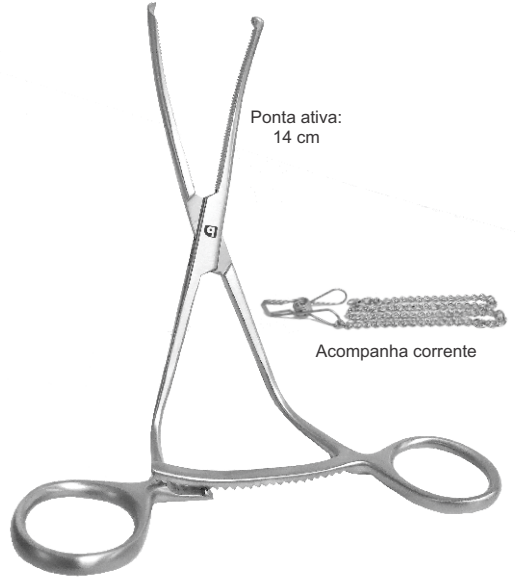

Ponta ativa:
14 cm

Acompanha corrente

KOCHER ANGULADA 90°
QD.675.00

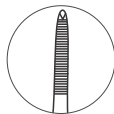

RETA

14 cm	QF.414.14
16 cm	QF.414.16
18 cm	QF.414.18

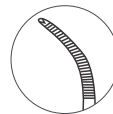

CURVA

14 cm	QF.415.14
16 cm	QF.415.16
18 cm	QF.415.18

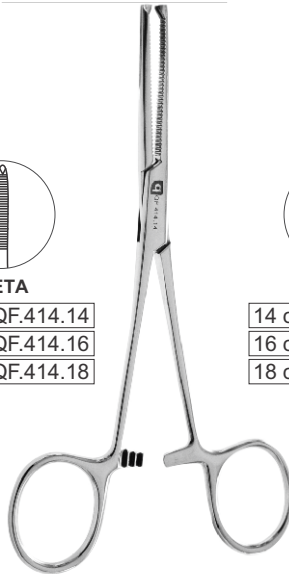

KOCHER

Pinças Diversas

Forceps | Pinzas



DEBAKEY CASTANHEDA Nº 4
12,5 cm | Cabo Angulado | Ponta 60°
QZ.238.04



DEBAKEY CASTANHEDA Nº 7
12 cm | Cabo Angulado | Tipo Derra
QZ.239.07

quinelato
instrumentos cirúrgicos

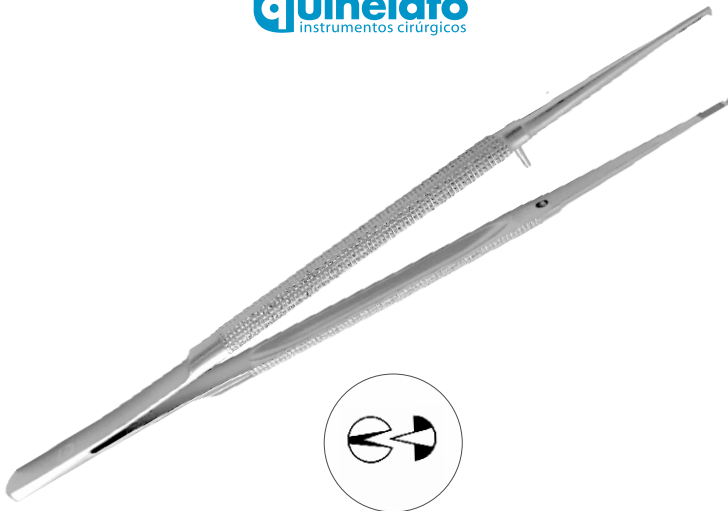

JABOMA | c/ Widia
QW.121.18

Pinças para Ossos

Bone Forceps | Pinzas para huesos



ROWE

Direito: QD.242.24
Esquerdo: QD.243.24



PINÇA WALSHAN

Direita: QD.316.21
Esquerda: QD.317.21



PINÇA ASCH

22 cm | QX.142.22



**SEPARADOR DE
CAVIDADE (Smith)**
QD.260.20



**ALVEOLÓTOMO
LUER CURVO**
15 cm | QD.145.15



BEYER CURVO
17 cm | QO.879.17



**PINÇA GOIVA
JANSEN BAIONETA**
18 cm | QX.396.01

Redução & Trauma

Reduction & Trauma | Reducción & Trauma



REDUÇÃO C/ PONTA
13 cm | QO.399.13



REDUÇÃO C/ PONTA
20 cm | QO.399.20



GANCHO GINESTET
QD.249.00



GANCHO BARROS
QD.248.15



PARAFUSO BYRD
(p/ tração) | QD.980.00



**PARAFUSO BYRD
MODIFICADO** | QD.985.00

Porta-Agulhas

Needle Holders | Porta Agujas



CRILE WOOD

S/ Widia

QJ.350.15 | 15 cm

C/ Widia

QW.700.15 | 15 cm



DERF

S/ Widia

QJ.326.12 | 12 cm

C/ Widia

QW.632.12 | 12 cm

QW.632.16 | 16 cm



MAYO HEGAR

S/ Widia

QJ.390.14 | 14 cm

QJ.390.17 | 17 cm

C/ Widia

QW.400.14 | 14 cm

QW.400.17 | 17 cm

Porta-Agulas

Needle Holders | Porta Agujas

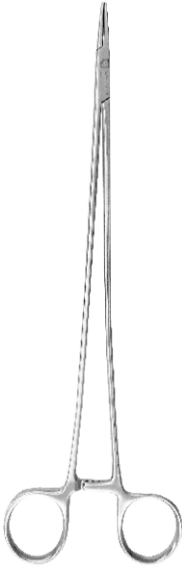

MICROVASCULAR
C/ Widia

18 cm | QW.714.18



**QUINELATO MICROVASCULAR
DELICADO**
C/ Widia

18 cm | QW.716.18

quinelato
instrumentos cirúrgicos



RYDER
C/ Widia

14 cm | QW.724.14

18 cm | QW.724.18



**QUINELATO
P/ FIO DE AÇO**

16 cm | QW.500.16

20 cm | QW.750.20

Fina-Fina



Fina-Romba



Romba-Romba



Fina-Romba	Reta	14 cm	QT102.14
Fina-Romba	Reta	16 cm	QT102.16
Fina-Romba	Curva	14 cm	QT107.14
Fina-Romba	Curva	16 cm	QT107.16
Romba-Romba	Reta	14 cm	QT100.14
Romba-Romba	Reta	16 cm	QT100.16
Romba-Romba	Curva	14 cm	QT105.14
Romba-Romba	Curva	16 cm	QT105.16
Fina-Fina	Reta	14 cm	QT104.14
Fina-Fina	Reta	16 cm	QT104.16
Fina-Fina	Curva	14 cm	QT109.14
Fina-Fina	Curva	16 cm	QT109.16

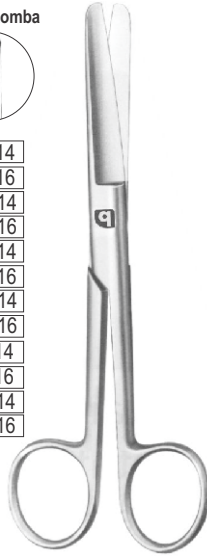

CIRÚRGICA



MAYO-STILLE

Reta	14 cm	QT.180.14
Reta	17 cm	QT.180.17
Curva	14 cm	QT.181.14
Curva	17 cm	QT.181.17



BOYD

15 cm	QZ.801.15
18 cm	QZ.801.18

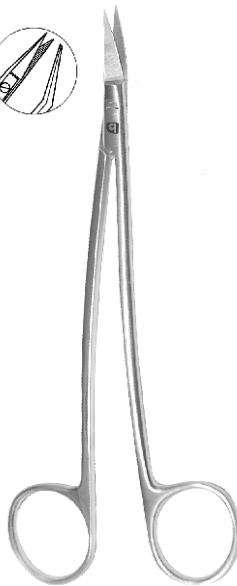

DEAN SERRILHADA

17 cm	QT.497.17
-------	-----------



Reta

11 cm	QT.568.11
13 cm	QT.568.13



Curva

11 cm	QT.567.11
13 cm	QT.567.13

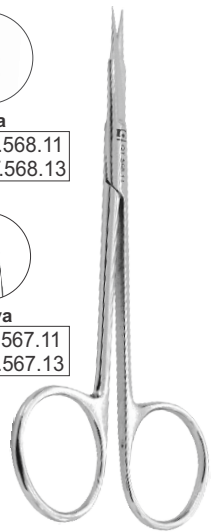

GOLDMANN FOX



Tesouras

Scissors | Tijeras



IRIS

Reta | 11,5 cm | QT.822.11
Curva | 11,5 cm | QT.823.11



SPENCER

11 cm | QT.824.11
14cm | QT.824.14

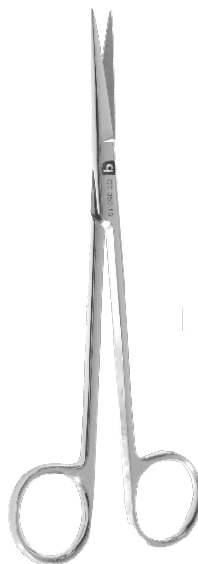

JOSEPH

Reta | 15 cm | QT.350.15
Curva | 15 cm | QT.351.15



UNIVERSAL

11 cm | QT.999.11



COROA E OURO | BEE-BEE

11 cm | QO.600.11

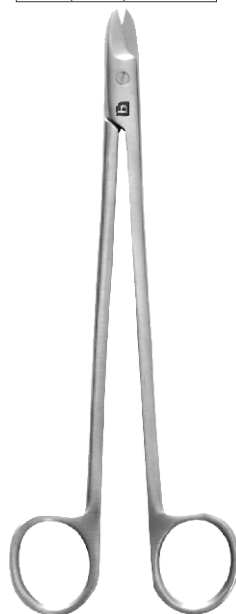

COROA E OURO | BEE-BEE

18 cm | QT.996.18

Reta	15 cm	QT.280.15
------	-------	-----------

Reta	18 cm	QT.280.18
------	-------	-----------

Curva	15 cm	QT.285.15
-------	-------	-----------

Curva	18 cm	QT.285.18
-------	-------	-----------

C/ WIDIA

Reta	15 cm	QW.912.15
------	-------	-----------

Reta	18 cm	QW.912.18
------	-------	-----------

Curva	15 cm	QW.913.15
-------	-------	-----------

Curva	18 cm	QW.913.18
-------	-------	-----------

C/ CORTE LASER

Reta	15 cm	QY.120.15
------	-------	-----------

Reta	18 cm	QY.120.18
------	-------	-----------

Curva	15 cm	QY.121.15
-------	-------	-----------

Curva	18 cm	QY.121.18
-------	-------	-----------

Reta	15 cm	QT.330.15
------	-------	-----------

Reta	18 cm	QT.330.18
------	-------	-----------

Curva	15 cm	QT.331.15
-------	-------	-----------

Curva	18 cm	QT.331.18
-------	-------	-----------

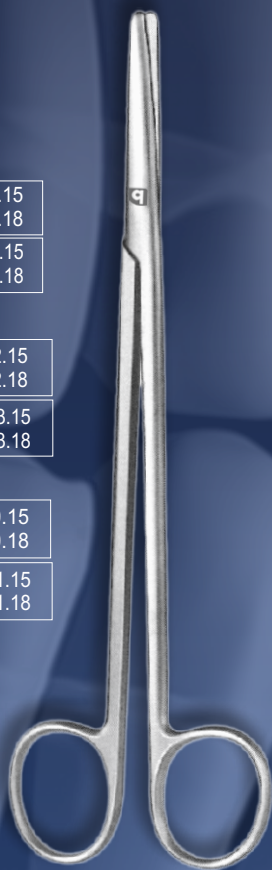

METZENBAUM

METZENBAUM
DELICADA

Material de apoio

Miscellaneous | Diversos

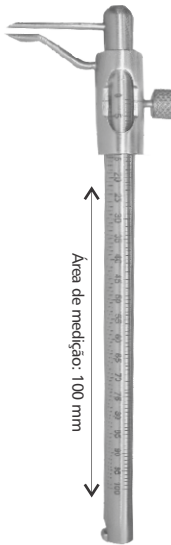

Área de medição: 100 mm

**PAQUÍMETRO
TIPO AGULHA**
QD.670.00

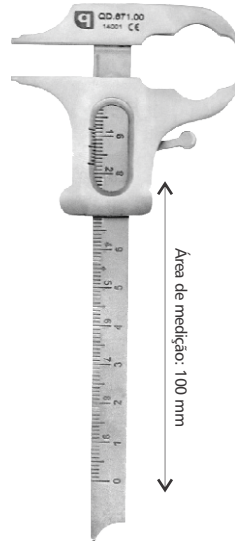

Área de medição: 100 mm

**PAQUÍMETRO
TIPO RÉGUA**
QD.671.00



COMPASSO CASTROVIEJO
QD.308.30

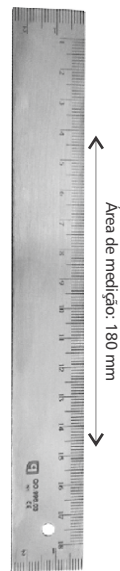

Área de medição: 180 mm

RÉGUA MILIMETRADA
QO.996.03

Material de apoio

Miscellaneous | Diversos



SERINGA PARA ANESTESIA
 QD.027.01
 C/ Aspiração



SERINGA PARA ANESTESIA
 QD.027.02
 C/ Refluxo



MAYO
 14 cm | QH.805.14



TENTACÂNULA
 14 cm | QH.160.14

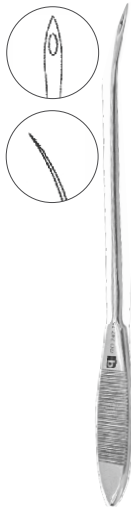

AGULHA OBWEGESER
 QD.247.15



AGULHA OBWEGESER
 QD.247.23



ESPÁTULA PONTA V
 QD.193.18

Material de apoio

Miscellaneous | Diversos



Ø 38mm
 200g
 16,5cm

MARTELO MEAD
 QD.992.16



Ø 25mm
 250g
 18cm

MARTELO LUCAE
 QO.471.25

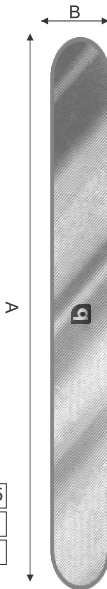

QD.196.01	20	6,5
QD.196.02	20	16
QD.196.10	20	10
	A	B

ESPÁTULA FLEXÍVEL

Quinelato
 instrumentos cirúrgicos



Fio: Até 1,0 mm

ALICATE CORTE PESADO
 QO.770.00

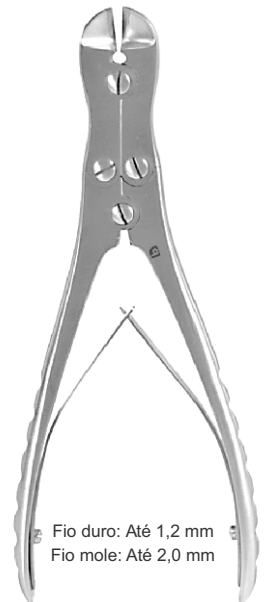

Fio duro: Até 1,2 mm
 Fio mole: Até 2,0 mm

ALICATE QUINELATO DUPLA ARTICULAÇÃO
 20 cm | QZ.900.20

ASSISTÊNCIA TÉCNICA QUINELATO

A mesma qualidade oferecida nos produtos Quinelato também pode ser encontrada nos serviços de Assistência Técnica da marca.

Como utilizar?

Caso você ou sua empresa necessitem de serviços dessa natureza, a Quinelato oferece total assistência técnica para consertos e reparos em instrumentos danificados.

Para ter acesso a este serviço, acesse o nosso site: www.quinelato.com.br, clique na guia **Serviços**, **Assistência Técnica**, imprima o formulário referente ao seu tipo de empresa e envie junto ao(s) instrumento(s) para nossa fábrica (o endereço está no formulário).

O valor dos serviços dependerá da análise dos problemas apresentados. O departamento responsável entrará em contato para passar orçamentos e/ou outras instruções.

Anote outros canais para saber mais sobre *Contratos de Manutenção e Assistência Técnica*:

(19) 2112.5225

atec@quinelato.com.br

Registro

Todos os produtos Quinelato são registrados na ANVISA (Agência Nacional de Vigilância Sanitária).

Garantia

Os instrumentos para Cirurgia Quinelato possuem garantia *Lifetime* contra defeitos de fabricação.

Conheça o “Manual Quinelato de Conservação de Instrumentos Cirúrgicos e Odontológicos”: Acesse www.quinelato.com.br

As imagens deste catálogo possuem caráter ilustrativo.

Os melhores instrumentos nas mãos
dos melhores profissionais.

Quinelato **75** anos

  quinelatoqualidade
www.quinelato.com.br
odonto@quinelato.com.br

Av. Pennwalt, 285
Rio Claro | SP
(19) 2112.5200
CEP 13505.650

ES.000.99 | ED 2018