

Os melhores instrumentos nas mãos
dos melhores profissionais.

Cirurgia Hospitalar



Cardiologia
Cardiology

Quinelato
instrumentos cirúrgicos



Cardiologia

Cardiology



SATINSKY

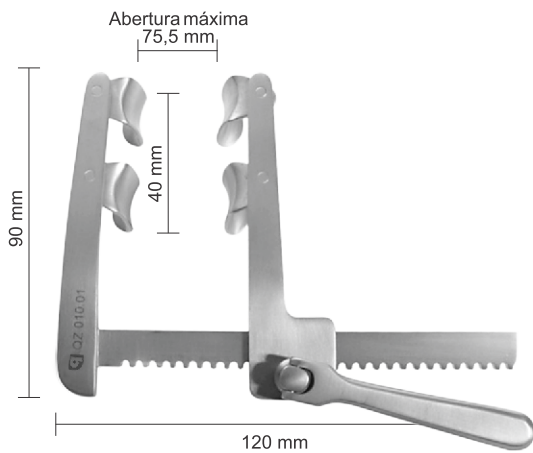

ANKENEY (P/ Criançinha)
QZ.010.01

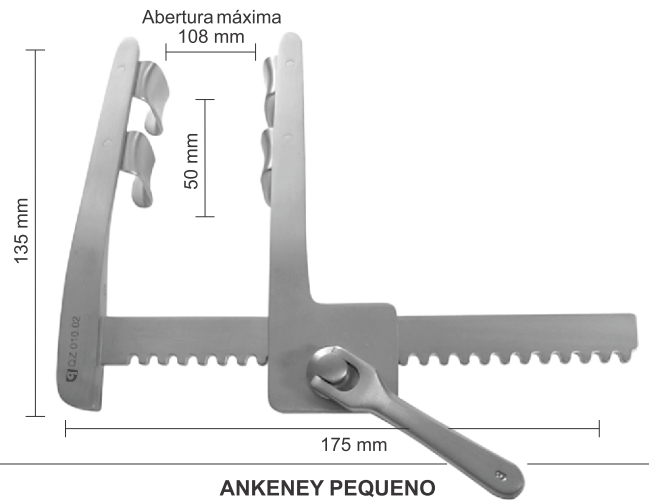

ANKENEY PEQUENO
QZ.010.02

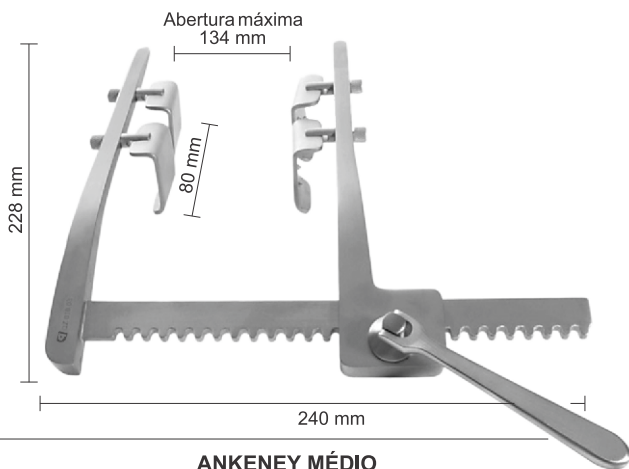

ANKENEY MÉDIO
QZ.010.03

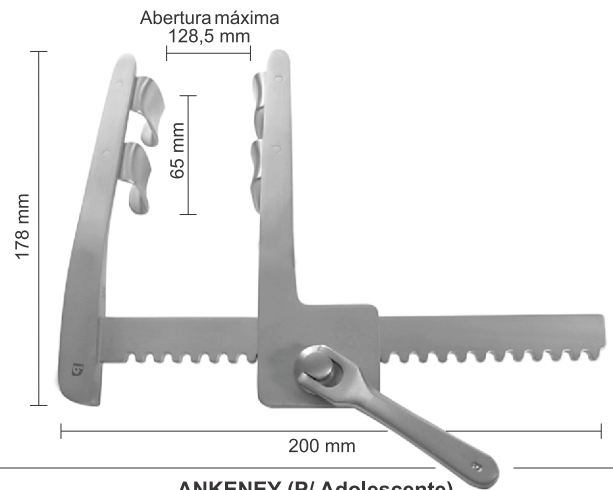

ANKENEY (P/ Adolescente)
QZ.010.05

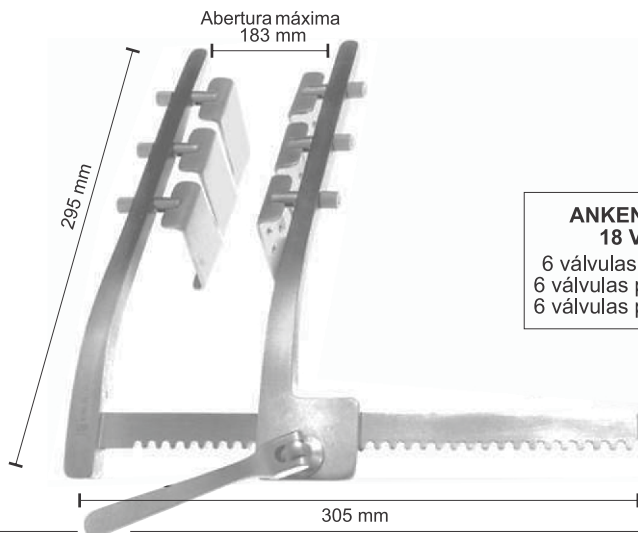

**ANKENEY GRANDE
18 VÁLVULAS**
6 válvulas grandes c/ garra
6 válvulas pequenas c/ garra
6 válvulas pequenas s/ garra

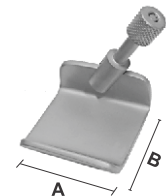
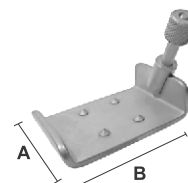

| | | C/ Garra | |
|---------|--|----------|------|
| | | A | B |
| Grande | | 38mm | 53mm |
| Pequeno | | 38mm | 38mm |

| | | S/ Garra | |
|---------|--|----------|------|
| | | A | B |
| Pequeno | | 38mm | 38mm |

ANKENEY GRANDE
QZ.010.04

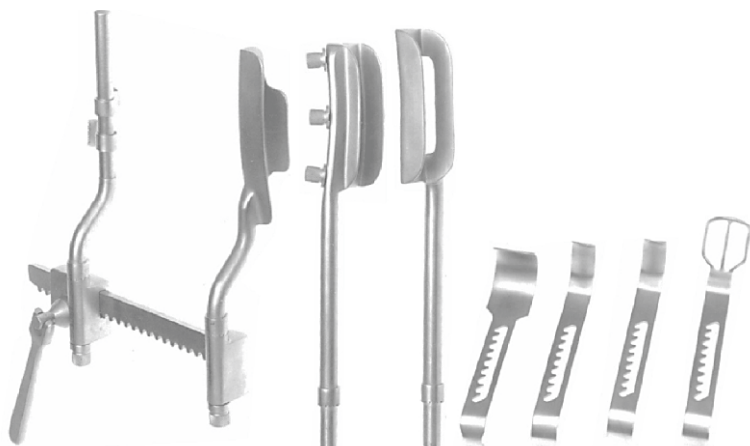

DINKHUYSEN | P/ MAMÁRIA / MITRAL
QZ.013.00



DINKHUYSEN MAMÁRIA
QZ.013.01

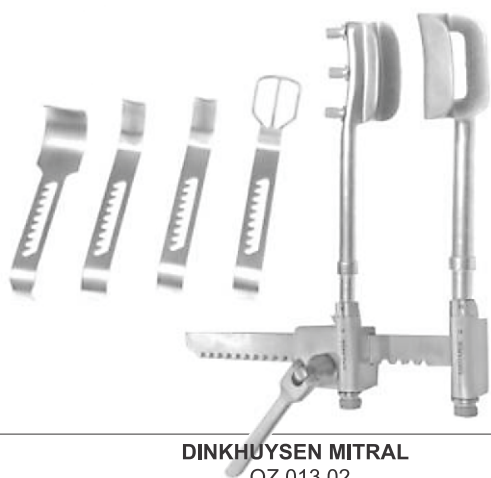

DINKHUYSEN MITRAL
QZ.013.02

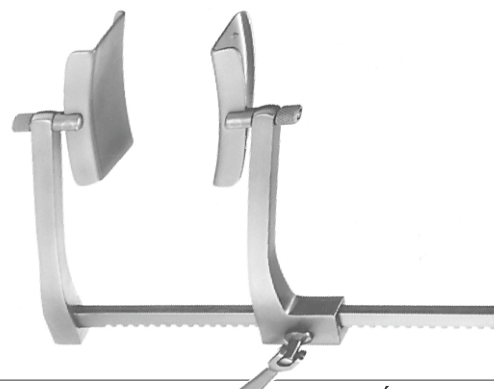

QUINELATO | AFASTADOR P/ TÓRAX
QZ.011.00

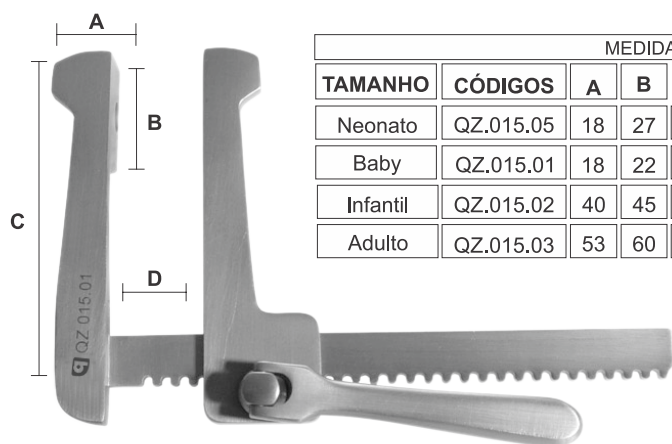

| | | MEDIDAS (mm) | | | |
|----------|-----------|--------------|----|-----|-----|
| TAMANHO | CÓDIGOS | A | B | C | D |
| Neonato | QZ.015.05 | 18 | 27 | 75 | 73 |
| Baby | QZ.015.01 | 18 | 22 | 75 | 86 |
| Infantil | QZ.015.02 | 40 | 45 | 135 | 180 |
| Adulto | QZ.015.03 | 53 | 60 | 170 | 230 |

FINOCHIETTO



ACESSÓRIO AFASTADOR MAMÁRIA
Acolado ao Finochietto (Dr. José Mussi) | QZ.015.00



| | |
|-------|-----------|
| 16 cm | QZ.030.16 |
| 19 cm | QZ.030.18 |



GELPI

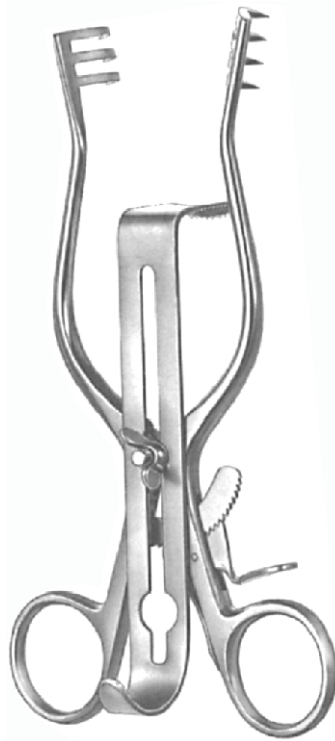

HENLEY
16 cm | QZ.042.00



AUTOSTÁTICO P/ TÚNEL
19 cm | QZ.603.00



ALM
7 cm | QG.714.07



EPICARDIO
QZ.050.50

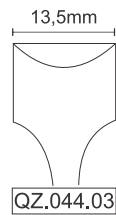
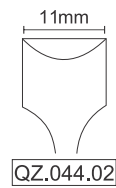

VENTRÍCULO
20 cm

| Códigos | Medidas mm | |
|-----------|------------|----|
| | A | B |
| QZ.043.01 | 24 | 20 |
| QZ.043.02 | 27 | 22 |



DINKHUYSEN
P/ Aorta



**QUINELATO
ATRIAL ESQUERDO**
21 cm | QZ.049.01



**QUINELATO
ATRIAL DIREITO**
21 cm | QZ.049.02

| | |
|-----|-----------|
| 4mm | QZ.702.04 |
| 5mm | QZ.702.05 |
| 7mm | QZ.702.07 |



KIRKLIN

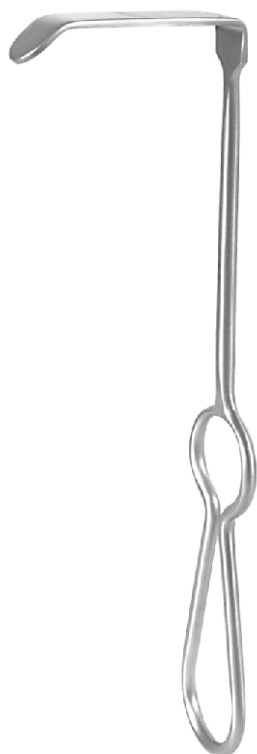

QUINELATO SIMPLES
QZ.604.00

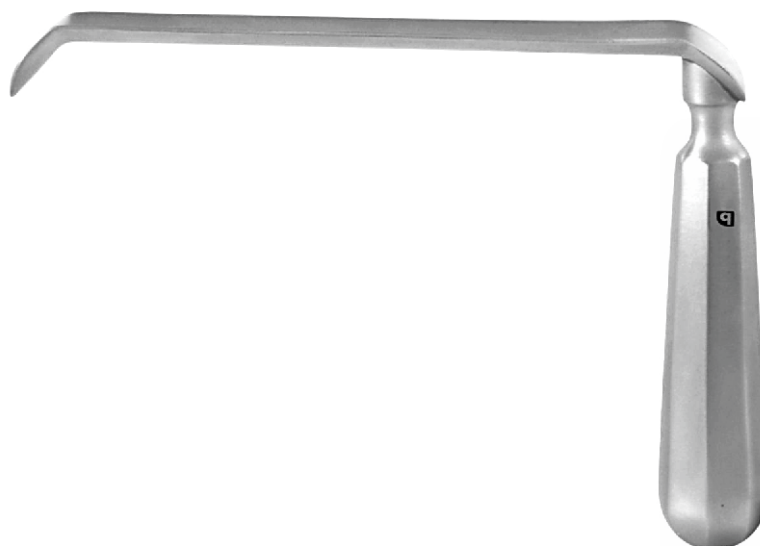

QUINELATO P/ DISSECÇÃO DE VEIA
14 cm | QZ.608.00

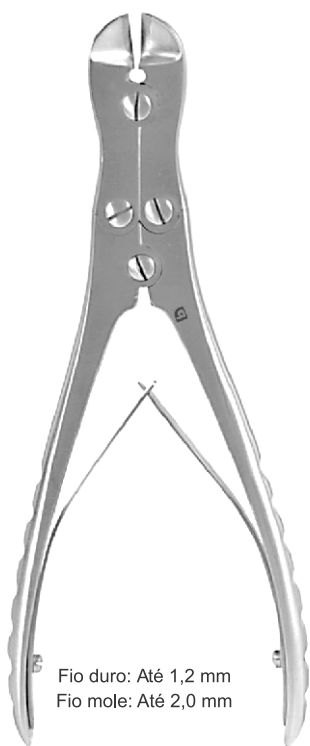

Fio duro: Até 1,2 mm
Fio mole: Até 2,0 mm

**ALICATE QUINELATO P/ FIO DE AÇO
DUPLA ARTICULAÇÃO**
20 cm | QZ.900.20



Para fios:
0,20 | 0,25 | 0,30

**ALICATE
AMARRIL**
QO.151.00



COSTÓTOMO GLUCK
22 cm | QZ.850.22



COSTÓTOMO COLLIN
18 cm | QZ.851.00



COSTÓTOMO GLUCK
22 cm | QZ.850.22

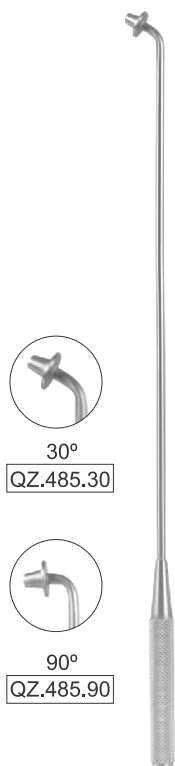

CÂNULA DINKHUYSEN
P/ Cardioplegia



**GANCHO P/
VASOS E VEIAS**

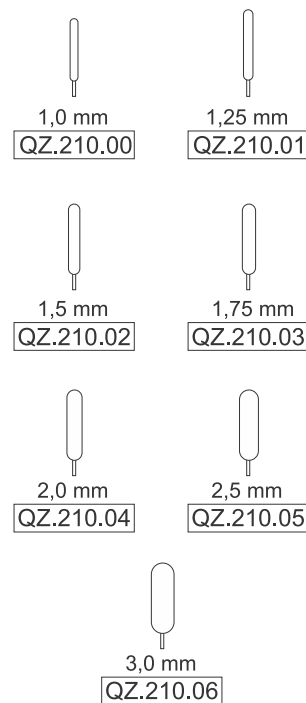

**DILATADORES
CORONÁRIA**



AGULHA C/ PONTA
(Heparina) 3 peças | QZ.220.03



SOPRADOR CO2
QZ.470.00



RUMMEL
QZ.906.26



GANCHO QUINELATO
P/ Simpatectomia | QZ.490.33



| | |
|-------|-----------|
| 20 cm | QZ.100.20 |
| 24 cm | QZ.100.24 |
| 30 cm | QZ.100.30 |



DEBAKEY



Ponta 2 mm

| | |
|-------|-----------|
| 16 cm | QZ.094.16 |
| 20 cm | QZ.094.20 |
| 24 cm | QZ.094.24 |
| 30 cm | QZ.094.30 |

Ponta 2,7 mm

| | |
|-------|-----------|
| 16 cm | QZ.096.16 |
| 20 cm | QZ.096.20 |
| 24 cm | QZ.096.24 |
| 30 cm | QZ.096.30 |

Ponta 3,5 mm

| | |
|-------|-----------|
| 16 cm | QZ.098.16 |
| 20 cm | QZ.098.20 |
| 24 cm | QZ.098.24 |
| 30 cm | QZ.098.30 |



DEBAKEY
DISSECÇÃO

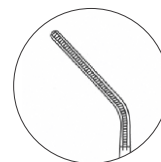

| | |
|-------|-----------|
| 20 cm | QZ.101.20 |
| 24 cm | QZ.101.24 |
| 30 cm | QZ.101.30 |



DEBAKEY DISSECÇÃO
ANGULADA

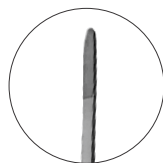

| | |
|-------|-----------|
| 24 cm | QW.102.24 |
| 30 cm | QW.102.30 |



DEBAKEY DISSECÇÃO
C/ Widia

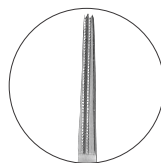

| | |
|-------|-----------|
| 24 cm | QZ.606.24 |
|-------|-----------|



DEBAKEY DISSECÇÃO
INTRATUNEL



| | |
|-------|-----------|
| 14 cm | QZ.110.14 |
| 16 cm | QZ.110.16 |
| 18 cm | QZ.110.18 |
| 20 cm | QZ.110.20 |
| 22 cm | QZ.110.22 |
| 24 cm | QZ.110.24 |



DIETRICH



Ponta 1,3 mm

| | |
|-------|-----------|
| 14 cm | QZ.112.14 |
| 16 cm | QZ.112.16 |
| 18 cm | QZ.112.18 |
| 20 cm | QZ.112.20 |
| 22 cm | QZ.112.22 |
| 24 cm | QZ.112.24 |
| 30 cm | QZ.112.30 |

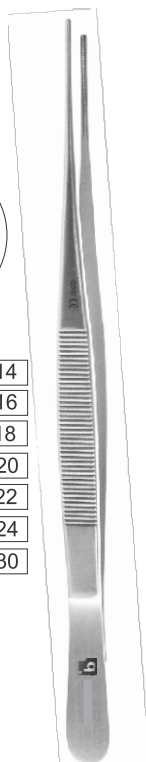

**DIETRICH
DELICADA**



| | |
|-------|-----------|
| 24 cm | QZ.602.24 |
|-------|-----------|



**DIETRICH DISSECÇÃO
INTRATÚNEL**

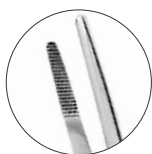

| | |
|-------|-----------|
| 18 cm | QZ.120.18 |
| 20 cm | QZ.120.20 |



POTTS-SMITH
C/ Serrilha

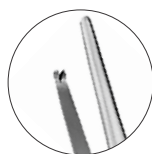

| | |
|-------|-----------|
| 18 cm | QZ.130.18 |
| 20 cm | QZ.130.20 |



POTTS-SMITH
C/ Dente de Rato



| | |
|-------|-----------|
| 18 cm | QW.120.18 |
| 20 cm | QW.120.20 |
| 22 cm | QW.120.22 |



POTTS-SMITH
C/ Wídia

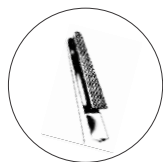

20 cm
QW.112.20



QUINELATO DELICADA
c/ Widia

20 cm
QW.118.20



QUINELATO DELICADA
Cabo redondo

QZ.309.00



DR. MARCELO
P/ MINITORACOTOMIA

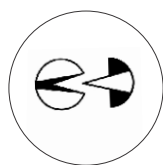

QW.121.18



JABOMA
c/ Widia

QZ.115.24



DINKHUYSEN
P/ Dissecção de Mamária

C/ Widia
QW.109.20
C/ Atrauma
QZ.113.20

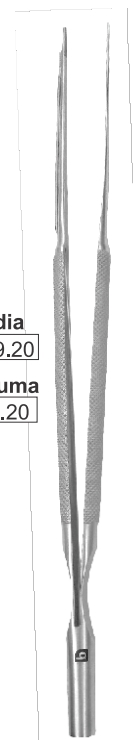

CLEANER DINKHUYSEN
C/ Soprador de CO2



| | |
|-------|-----------|
| 6 cm | QZ.300.06 |
| 7 cm | QZ.300.07 |
| 8 cm | QZ.300.08 |
| 9 cm | QZ.300.09 |
| 10 cm | QZ.300.10 |
| 11 cm | QZ.300.11 |
| 12 cm | QZ.300.12 |



BULLDOG ATRAUMA
Reta

| | |
|---------|-----------|
| 5,5 cm | QZ.301.06 |
| 6,5 cm | QZ.301.07 |
| 7,5 cm | QZ.301.08 |
| 8,5 cm | QZ.301.09 |
| 9,5 cm | QZ.301.10 |
| 10,5 cm | QZ.301.11 |
| 11,5 cm | QZ.301.12 |



BULLDOG ATRAUMA
Curva

| Ponta | Código |
|-------|-----------|
| 8 mm | QZ.317.08 |
| 12 mm | QZ.317.12 |



BULLDOG CLAMP
Angulada

| | |
|-------|-----------|
| 6 cm | QZ.304.06 |
| 7 cm | QZ.304.07 |
| 9 cm | QZ.304.09 |
| 11 cm | QZ.304.11 |



BULLDOG GLOVER
Reta c/ Mola

| | |
|--------|-----------|
| 5,5cm | QZ.303.06 |
| 6,5cm | QZ.303.07 |
| 8,5cm | QZ.303.09 |
| 10,5cm | QZ.303.11 |

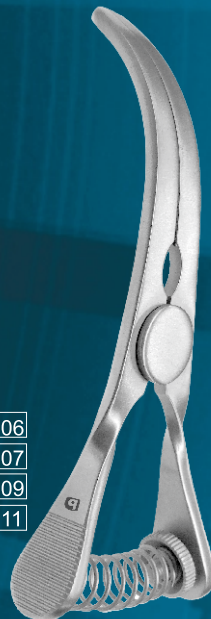

BULLDOG GLOVER
Curva c/ Mola

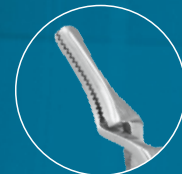

Reta
5,5cm | QZ.114.05



Curva
4 cm | QZ.115.04



BULLDOG DIEFFENBACH
Reta e Curva



25 cm | QE.201.25

ORDENHA

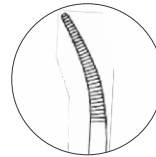

21 cm | QZ.211.21



MOYNIHAN

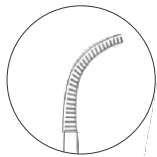

23 cm | QZ.205.23

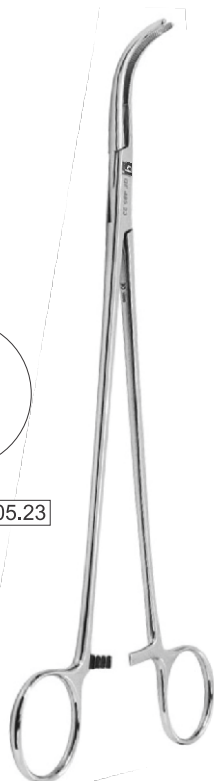

MIXTER

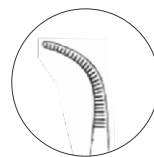

14 cm | QZ.379.14



BABY-MIXTER



18 cm | QZ.209.18

GEMINI

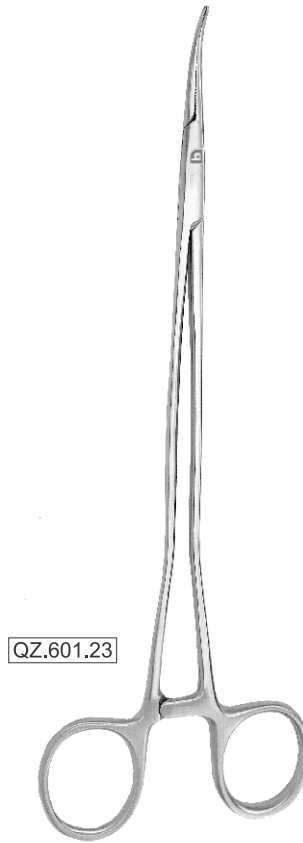

QZ.601.23

**GEMINI LONGA
MODIFICADA**



18 cm | QZ.213.18

SCHNIDT



24 cm | QZ.207.24

SEMB
Passa fio



34 cm | QZ.217.34

VÁLVULA - MITRAL

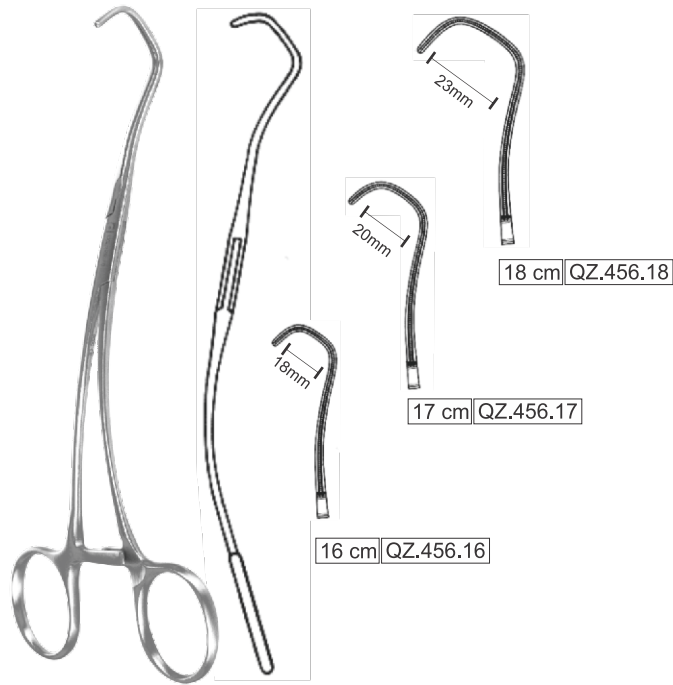

DERRA

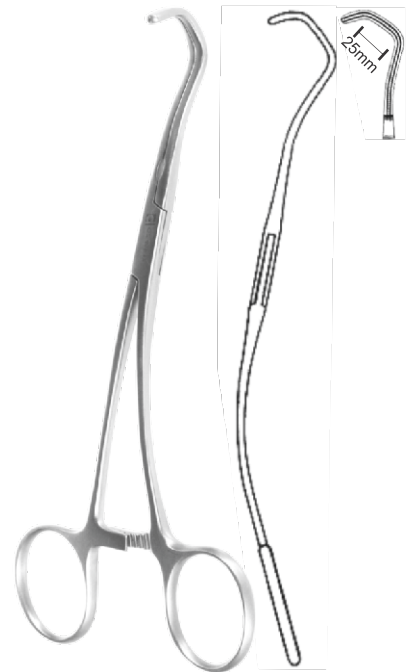

DERRA FORTE
QZ.465.17

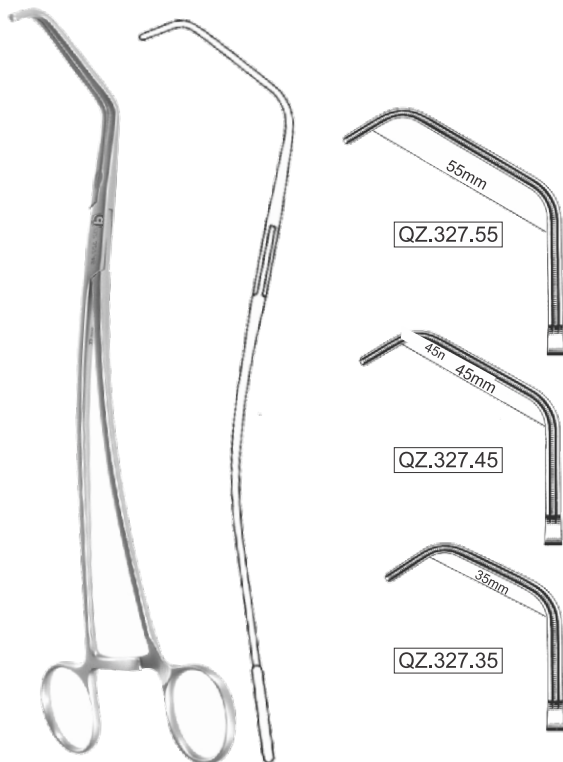

SATINSKY
24,5 cm



BECK



PINÇAS CLAMP AORTA E COARCTAÇÃO

Cardiologia

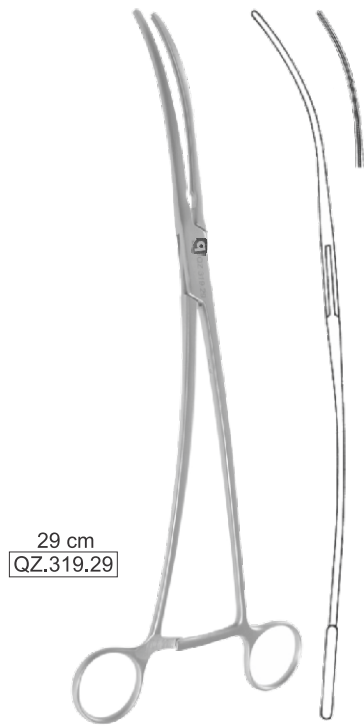

29 cm
QZ.319.29

DEBAKEY

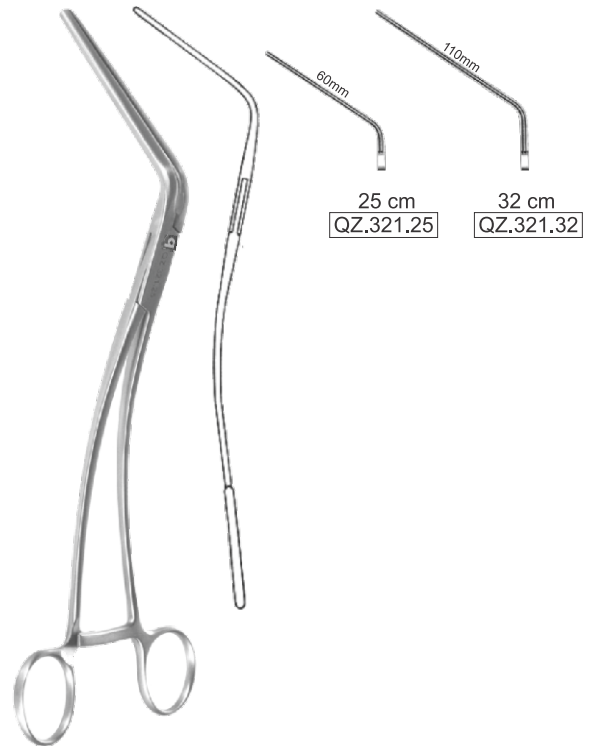

25 cm
QZ.321.25

32 cm
QZ.321.32

DEBAKEY 60°

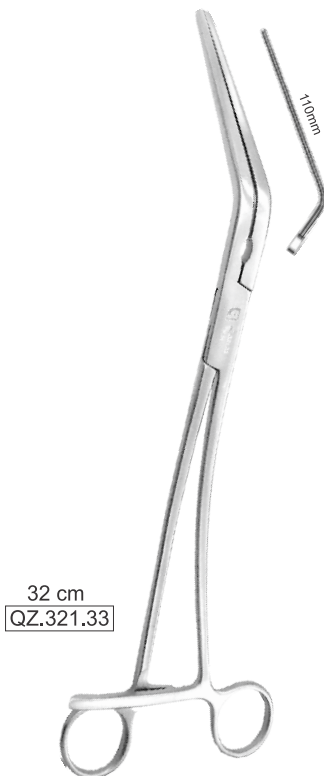

32 cm
QZ.321.33

DEBAKEY 60°
C/ Cremalheira longa

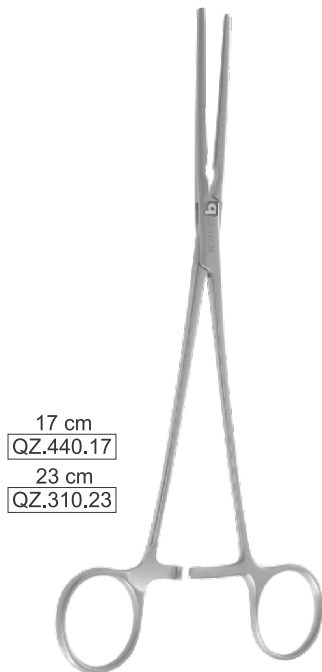

17 cm
QZ.440.17
23 cm
QZ.310.23

DEBAKEY
COARCTAÇÃO RETA

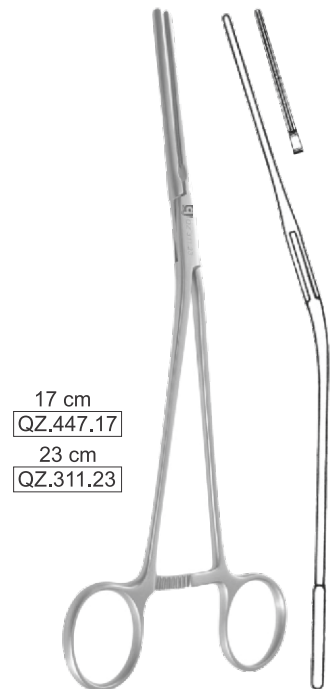

17 cm
QZ.447.17
23 cm
QZ.311.23

DEBAKEY COARCTAÇÃO
ANGULADA NO CABO



18 cm
QZ.313.18

**QUINELATO
AORTA P/ CRIANÇA**



23 cm
QZ.325.23

**QUINELATO
MÉDIA**

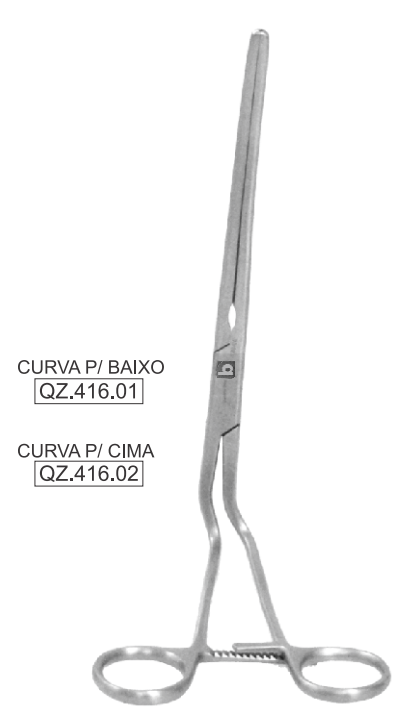

CURVA P/ BAIXO
QZ.416.01

CURVA P/ CIMA
QZ.416.02

**QUINELATO P/
TORACOTOMIA**



22 cm
QZ.333.22

LAMBERT KAY

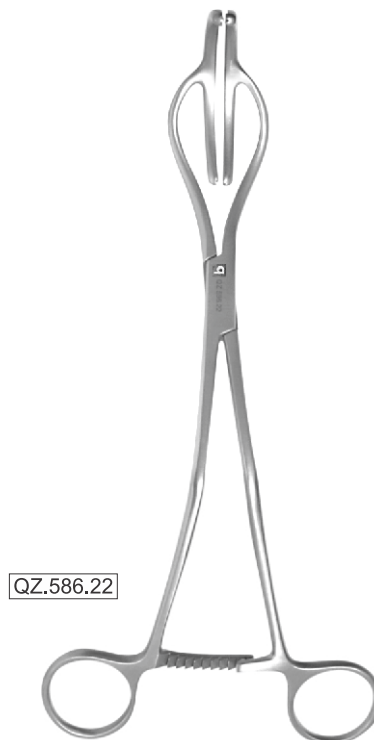

QZ.586.22

LEMOLE STRONG

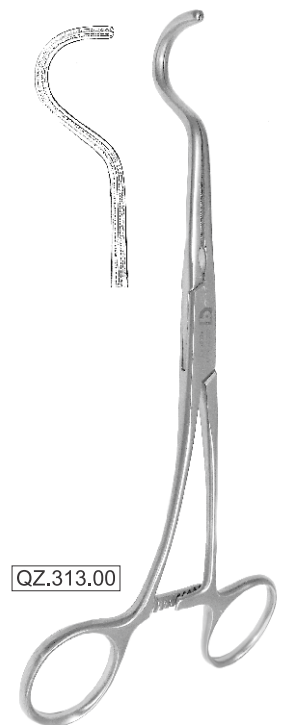

QZ.313.00

CLAMP TIPO COLHER



PINÇAS CLAMP VASCULAR

Cardiologia



**PINÇA DEBAKEY
CURVA P/ AORTA**
26 cm | QZ.319.26



**CLAMP VASCULAR ATRAUMÁTICO
GLOVER | CURVA LEVE**
26 cm | QZ.418.03



**CLAMP VASCULAR ATRAUMÁTICO
GLOVER | COLHER**
220 / 60 mm | QZ.418.05



**PINÇA DEBAKEY P/ ANEURISMA
CURVA**
30 cm | QZ.419.30



**PINÇA DEBAKEY-RUMEL
CURVA**
25 cm | QZ.420.01



**PINÇA DEBAKEY P/ LIGADURA
CURVA**
26 cm | QZ.423.26

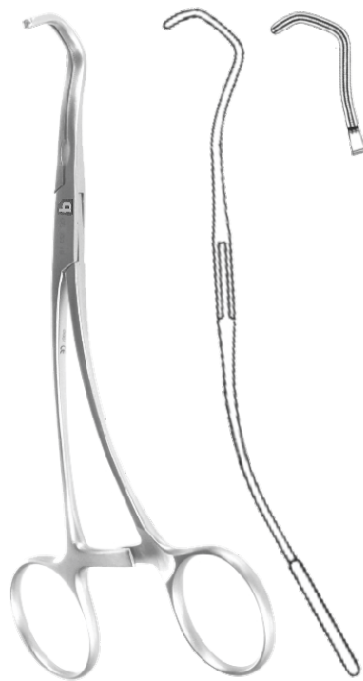

16,5 cm
QZ.323.16

27 cm
QZ.323.28

COOLEY



18 cm
QZ.317.18

**QUINELATO
CLAMP VASCULAR**

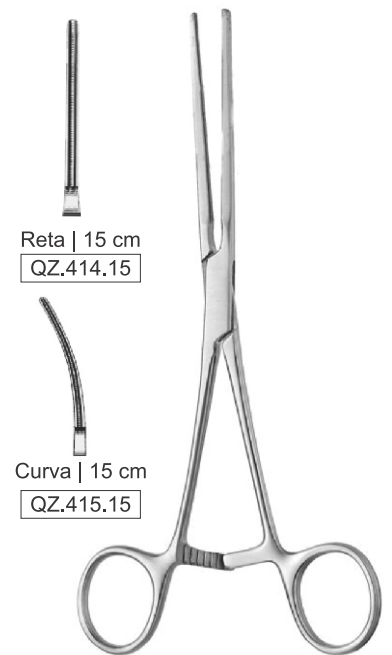

Reta | 15 cm
QZ.414.15

Curva | 15 cm
QZ.415.15

BAINBRIDGE

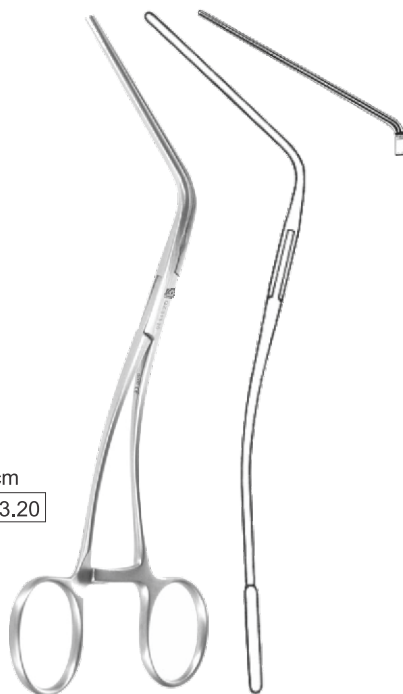

20 cm
QZ.313.20

**DEBAKEY VASCULAR
PERIFÉRICA ANGULADA**

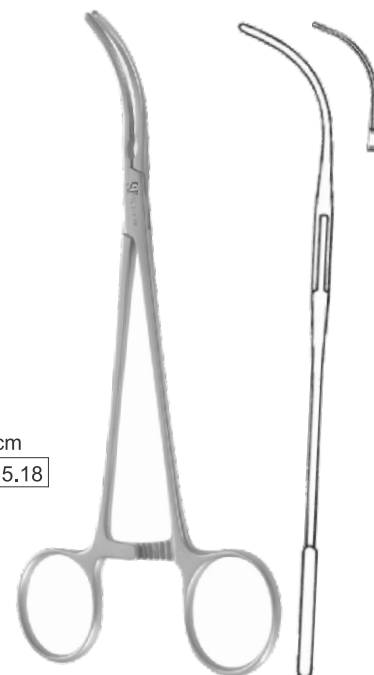

18 cm
QZ.315.18

**DEBAKEY VASCULAR
PERIFÉRICA CURVA**



PINÇAS CLAMP
DEBAKEY NEONATO
CASTANHEDA

Cardiologia



**DEBAKEY NEONATO
CASTANHEDA**

12,5 cm | QZ.236.01

Cabo: Reto | Ponta: Reta



**DEBAKEY NEONATO
CASTANHEDA**

12,5 cm | QZ.237.01

Cabo: Curvo | Ponta: Reta



**DEBAKEY NEONATO
CASTANHEDA**

12 cm | QZ.237.16

Curva Colher

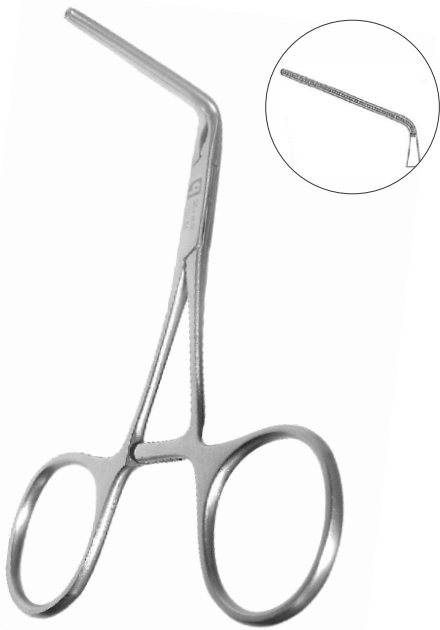

**DEBAKEY NEONATO
CASTANHEDA**
12,5 cm | QZ.236.05
Cabo: Reto | Ponta: 90°

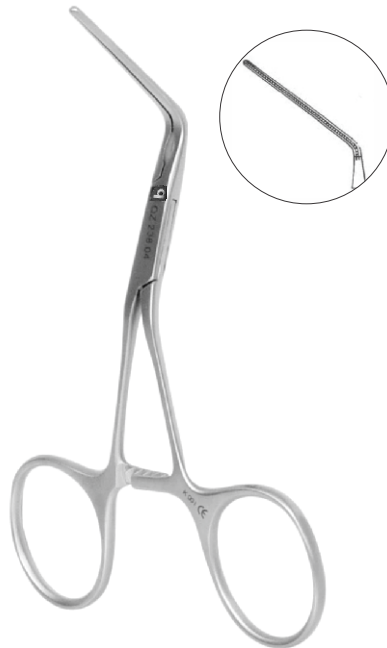

**DEBAKEY NEONATO
CASTANHEDA**
12,5 cm | QZ.238.04
Cabo: Angulado | Ponta: 60°



**DEBAKEY NEONATO
CASTANHEDA**
12,5 cm | QZ.238.05
Cabo: Angulado | Ponta: 90°



**DEBAKEY NEONATO
CASTANHEDA**
12 cm | QZ.237.07
Tipo Derra | Cabo: Curvo

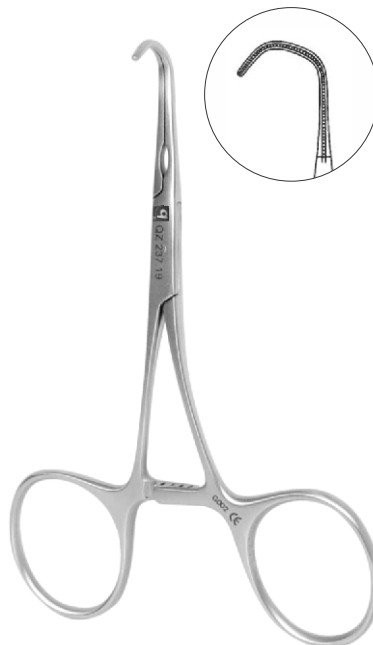

**DEBAKEY NEONATO
CASTANHEDA**
11,5 cm | QZ.237.19
Tipo Derra | Ponta: Delicada



**DEBAKEY NEONATO
CASTANHEDA**
12 cm | QZ.239.07
Tipo Derra | Cabo: Angulado

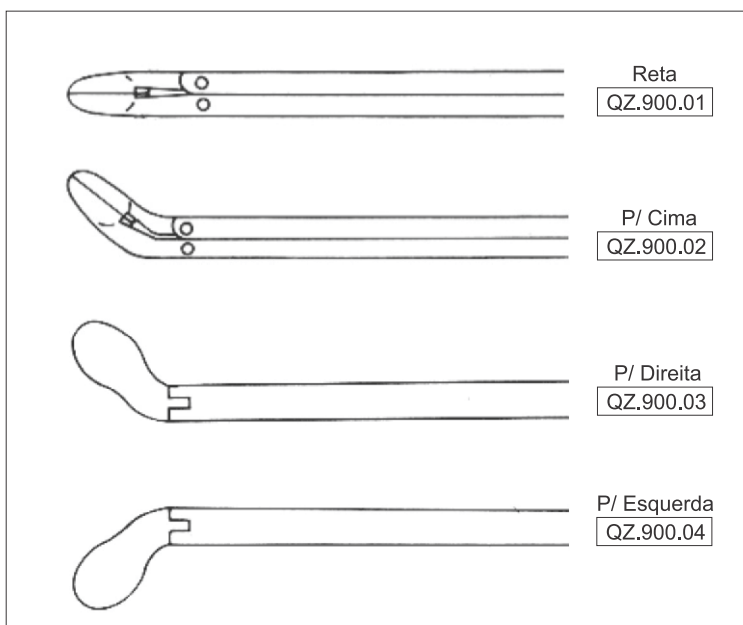

SACA-CÁLCIO
20 cm



| C/ Trava | |
|----------|-----------|
| 14 cm | QW.320.14 |
| 18 cm | QW.300.18 |
| 21 cm | QW.300.21 |

| S/ Trava | |
|----------|-----------|
| 14 cm | QW.330.14 |
| 18 cm | QW.330.18 |
| 21 cm | QW.330.21 |

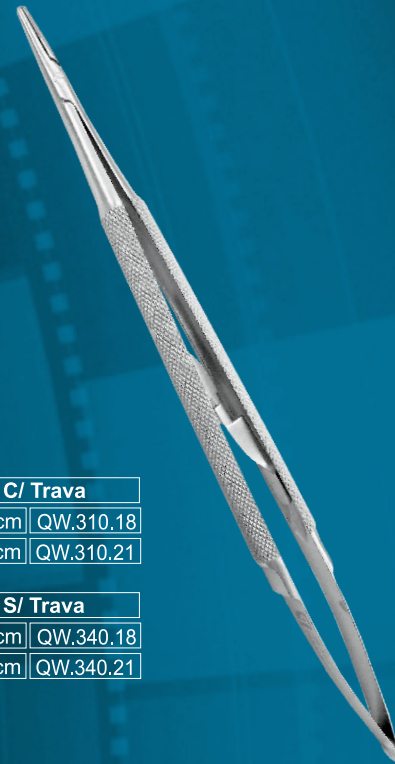

| C/ Trava | |
|----------|-----------|
| 18 cm | QW.310.18 |
| 21 cm | QW.310.21 |

| S/ Trava | |
|----------|-----------|
| 18 cm | QW.340.18 |
| 21 cm | QW.340.21 |

CASTROVIEJO

CASTROVIEJO
CABO REDONDO

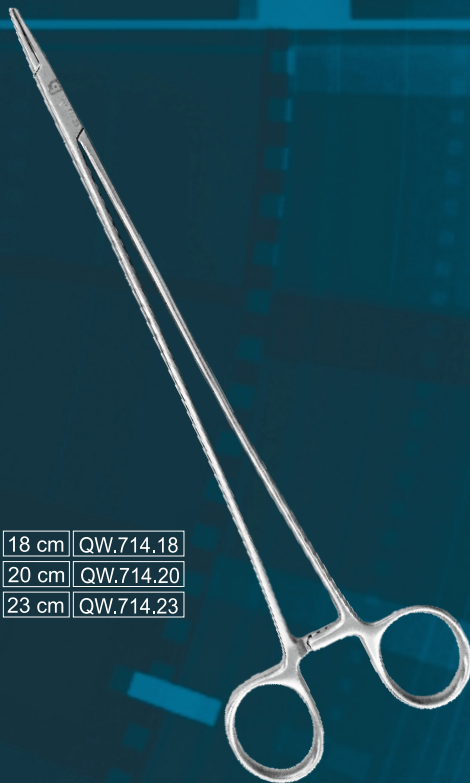

| | |
|-------|-----------|
| 18 cm | QW.714.18 |
| 20 cm | QW.714.20 |
| 23 cm | QW.714.23 |

MICROVASCULAR



| | |
|-------|-----------|
| 18 cm | QW.716.18 |
| 20 cm | QW.716.20 |
| 23 cm | QW.716.23 |

QUINELATO MICROVASCULAR
DELICADO



| | |
|-------|-----------|
| 17 cm | QW.770.17 |
| 20 cm | QW.770.20 |

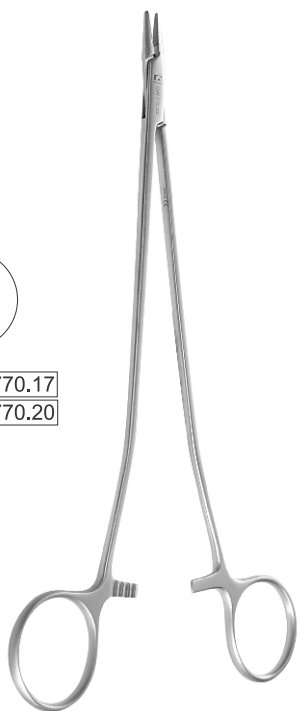

**QUINELATO
P/ CORONÁRIA**

| | |
|-------|-----------|
| 17 cm | QW.720.17 |
| 20 cm | QW.720.20 |



SAROT

| | |
|-------|-----------|
| 22 cm | QW.522.22 |
|-------|-----------|



**QUINELATO
BI-ARTICULADO**

| | |
|-------|-----------|
| 14 cm | QW.724.14 |
| 18 cm | QW.724.18 |
| 20 cm | QW.724.20 |
| 23 cm | QW.724.23 |
| 25 cm | QW.724.25 |

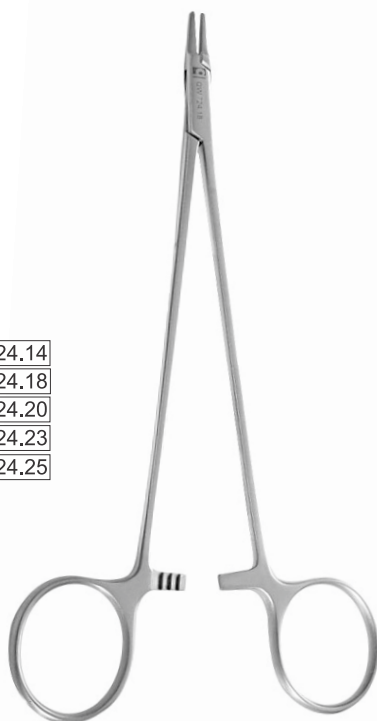

RYDER

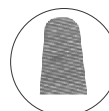

| | |
|-------|-----------|
| 16 cm | QW.500.16 |
| 20 cm | QW.750.20 |
| 25 cm | QW.750.25 |



QUINELATO P/ FIO DE AÇO



| Reta | |
|-------|-----------|
| 11 cm | QZ.772.11 |
| 14 cm | QZ.772.14 |

| Curva | |
|-------|-----------|
| 11 cm | QZ.771.11 |
| 14 cm | QZ.771.14 |

CASTROVIEJO



QZ.770.45

CASTROVIEJO 45°



QZ.770.13

CASTROVIEJO 130°

METZENBAUM

Reta

| | |
|-------|-----------|
| 15 cm | QZ.810.15 |
| 18 cm | QZ.810.18 |
| 20 cm | QZ.810.20 |

Curva

| | |
|-------|-----------|
| 15 cm | QZ.811.15 |
| 18 cm | QZ.811.18 |
| 20 cm | QZ.811.20 |
| 23 cm | QZ.811.23 |
| 26 cm | QZ.811.26 |



**METZENBAUM
DELICADA**

Reta

| | |
|-------|-----------|
| 15 cm | QZ.812.15 |
| 18 cm | QZ.812.18 |
| 20 cm | QZ.812.20 |

Curva

| | |
|-------|-----------|
| 15 cm | QZ.813.15 |
| 18 cm | QZ.813.18 |
| 20 cm | QZ.813.20 |



**METZENBAUM
LONGA CURVA**

23 cm | QZ.607.23

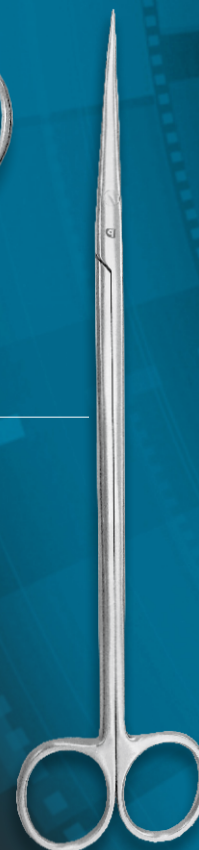



TESOURAS

Cardiologia

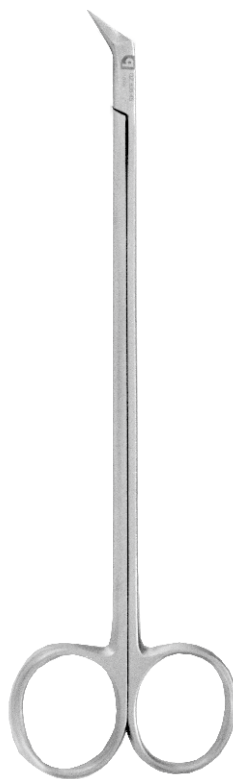

DIETRICH | 45°
18 cm | QZ.835.45

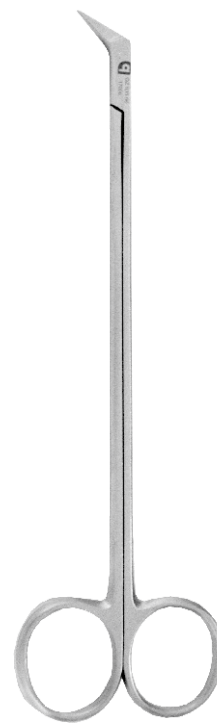

DIETRICH | 60°
18 cm | QZ.835.60

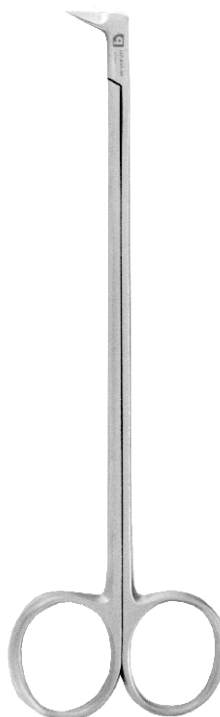

DIETRICH | 90°
18 cm | QZ.835.90

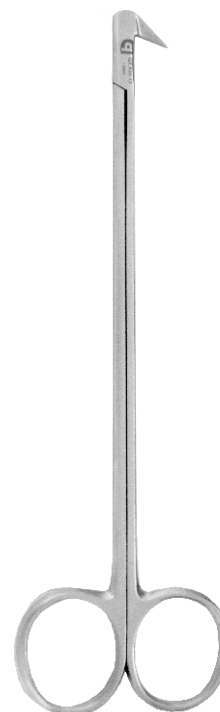

DIETRICH | 130°
18 cm | QZ.835.13

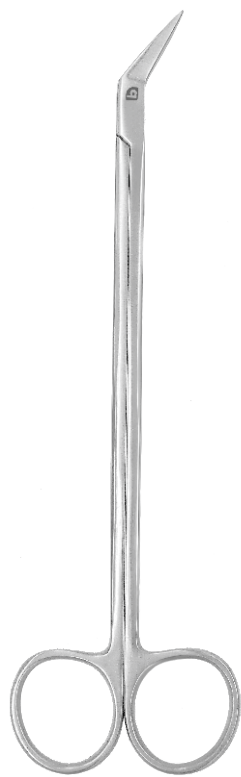

POTTS SMITH | 25°
18 cm | QZ.821.25

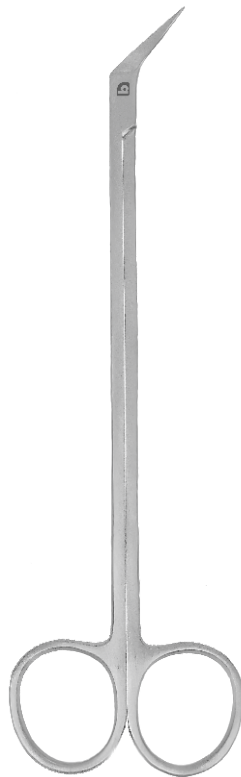

POTTS SMITH | 45°
18 cm | QZ.821.45



POTTS SMITH | 60°
18 cm | QZ.821.60

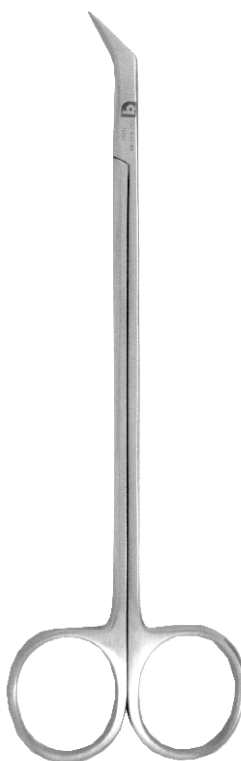

DEBAKEY 45°
18 cm | QZ.831.45

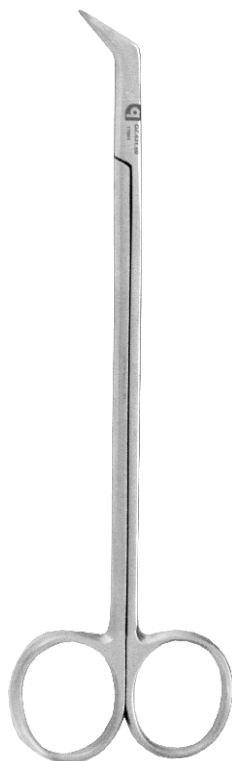

DEBAKEY 60°
18 cm | QZ.831.60



BOYD
15 cm | QZ.801.15
18 cm | QZ.801.18



Quinelato

instrumentos cirúrgicos