

Os melhores instrumentos nas mãos
dos melhores profissionais.

Cirurgia Hospitalar



Ortopedia
Orthopedic Surgery

quinelato
instrumentos cirúrgicos



BOCA SERRILHADA
19 cm | Ponta Fina: 2mm
QO.821.01

PUXA FIO
Fio de 17 cm
QO.821.02

UNIVERSAL
21 cm
QO.827.01

PRESSÃO
18 cm | QO.830.01
20 cm | QO.830.02



Ponta | 2mm
QO.822.02

Ponta | 3mm
QO.822.03

Ponta | 5mm
QO.822.05

DUPLA FORÇA PARA PUXAR FIOS C/ WIDIA
18 cm

DUPLA FORÇA | CORTE FRONTAL C/ WIDIA
21 cm | QO. 823.23

DUPLA FORÇA | CORTE LATERAL C/ WIDIA
25 cm | QO.824.25

Pliers
Orthopedic Surgery



TURQUESA C/ WIDIA
15 cm
QO.828.15



**CORTA FIO DE AÇO
C/ WIDIA ANGULADO**
21 cm | Fio até 2 mm
QO.825.02

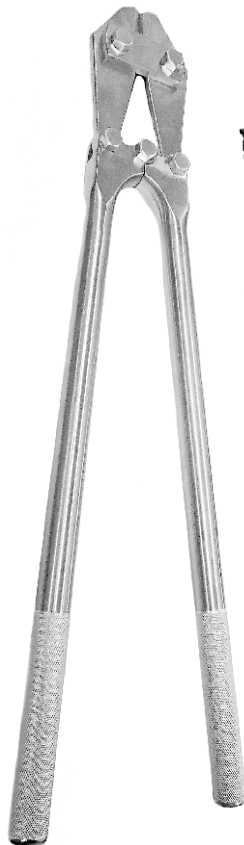

12" | 30 cm
Fios até 4mm
QO.826.12

18" | 45 cm
Fios até 5mm
QO.826.18

24" | 60 cm
Fios até 6mm
QO.826.24

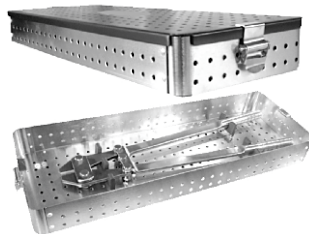

**CAIXA P/ ALICATE
STEINMANN**

P/ modelo: 12" | 30 cm
QQ-052-51

P/ modelo: 18" | 45 cm
QQ-052-52

P/ modelo: 24" | 60 cm
QQ-052-53

STEINMANN



**DUPLA FORÇA
CORTE FRONTAL
C/ WIDIA**



UNIVERSAL



PRESSÃO

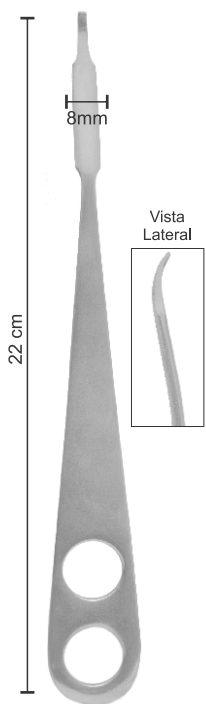

HOHMANN Nº 1
QO.940.01

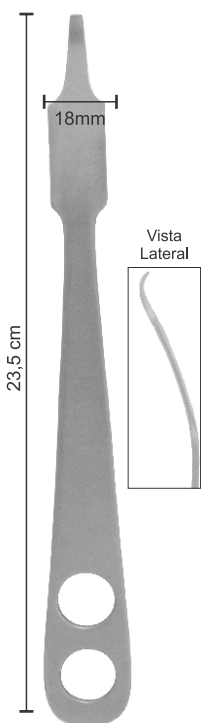

HOHMANN Nº 2
QO.940.02

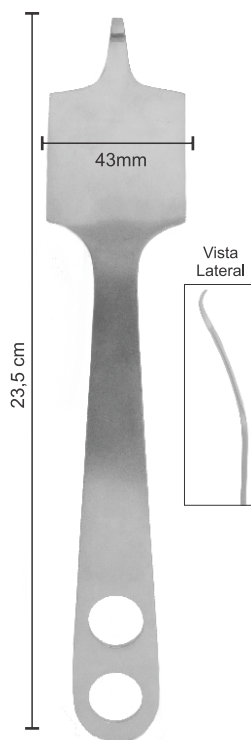

HOHMANN Nº 3
QO.940.03

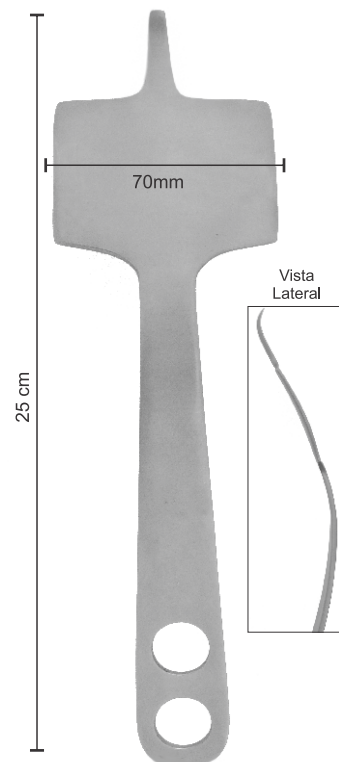

HOHMANN Nº 4
QO.940.04

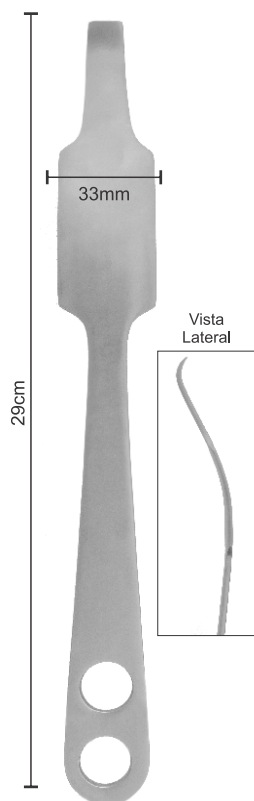

HOHMANN Nº 7
QO.940.07

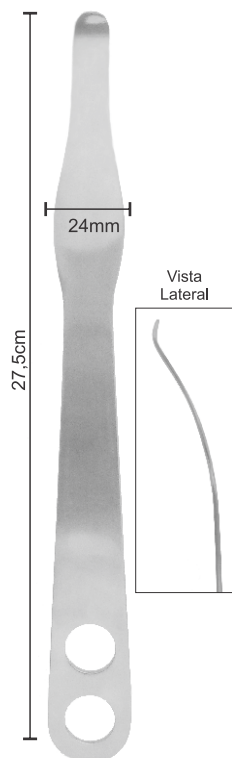

HOHMANN Nº 8
QO.940.08

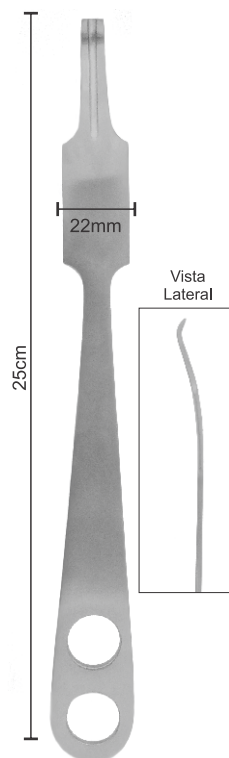

HOHMANN Nº 9
QO.940.09

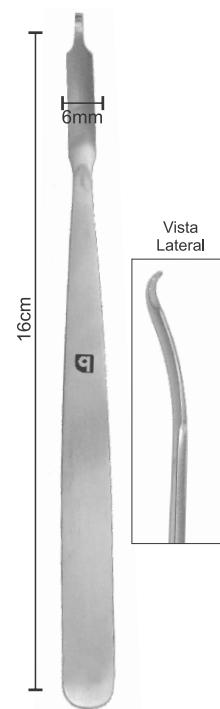

HOHMANN PONTA ESTREITA
6mm | QU.399.18

Hohmann Bone Levers
Orthopedic Surgery

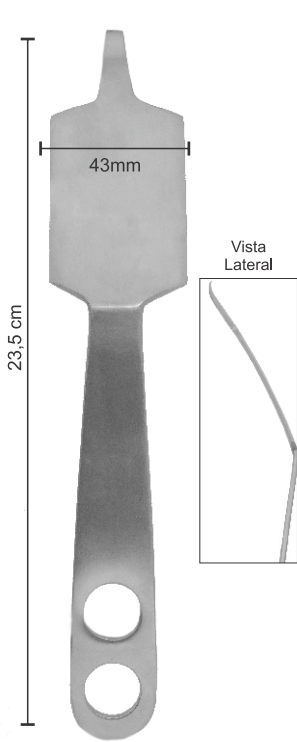

HOHMANN Nº 5
QO.940.05

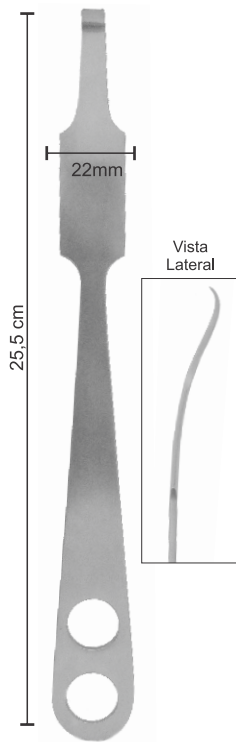

HOHMANN Nº 6
QO.940.06

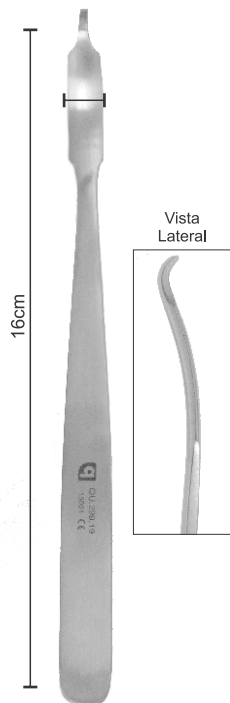

HOHMANN PONTA ESTREITA
8mm | QU.399.19

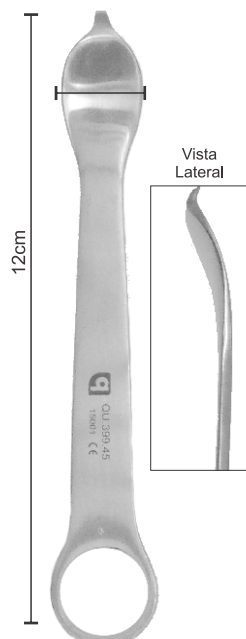

HOHMANN PONTA LARGA
15mm | QU.399.45



HOHMANN Nº 4
QO.940.04

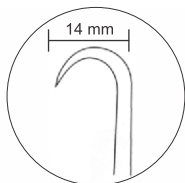

AGUDO



QG.220.01



QG.220.02



QG.220.03



QG.220.04

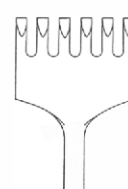

QG.220.06

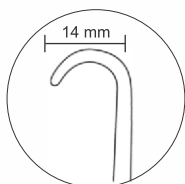

ROMBO



QG.221.01



QG.221.02



QG.221.03

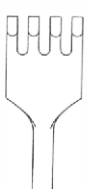

QG.221.04

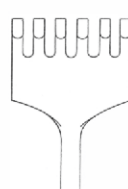

QG.221.06



VOLKMANN
23 cm

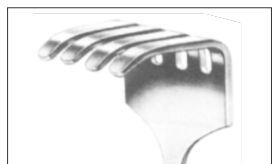

QG.281.04
40 x 40 mm | c/ 4 dentes

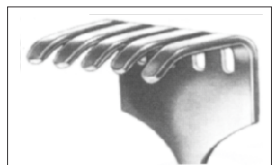

QG.281.05
45 x 50 mm | c/ 5 dentes

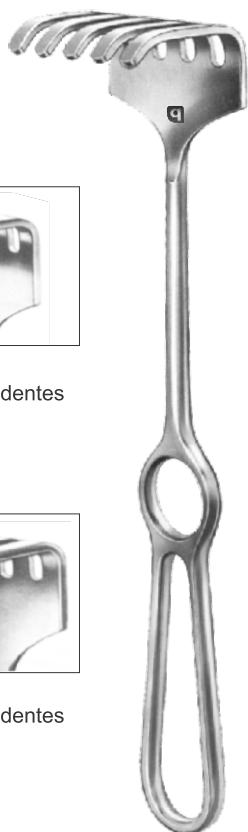

ISRAEL
25 cm

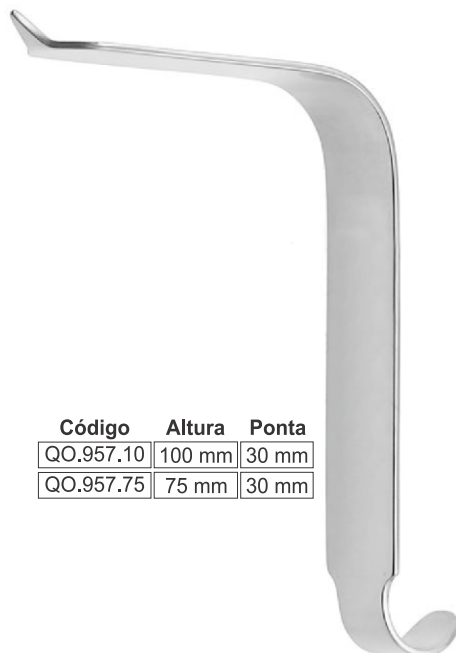

TAYLOR

Código	Altura	Ponta
QO.957.10	100 mm	30 mm
QO.957.75	75 mm	30 mm



BENNET
QG.951.02



WILLIGER | 16 cm
QO.960.00



RETA
QO.292.15



CURVA
QO.293.15



RUGINA FARABEU
15 cm

05 mm	QO.380.05
10 mm	QO.380.10
15 mm	QO.380.15
20 mm	QO.380.20
25 mm	QO.380.25

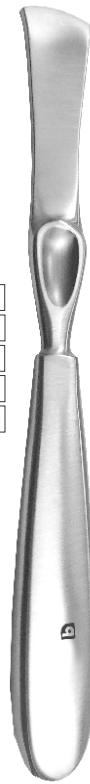

RUGINA LAMBOTTE
21 cm

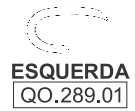

ESQUERDA
QO.289.01



DIREITA
QO.289.02



RUGINA DOYEN
17 cm



BLOUNT
18cm | QO.955.18



BLOUNT
26cm | QO.955.26



BLOUNT DUPLO
26cm | QO.956.02

Código	Ponta	Comp.
QN.761.10	10 mm	25 cm
QN.761.13	13 mm	25 cm
QN.761.19	19 mm	35 cm
QN.761.25	25 mm	35 cm

10 / 13 / 19 / 25 mm

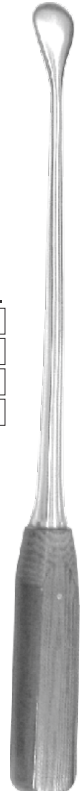

COBB

STILLE

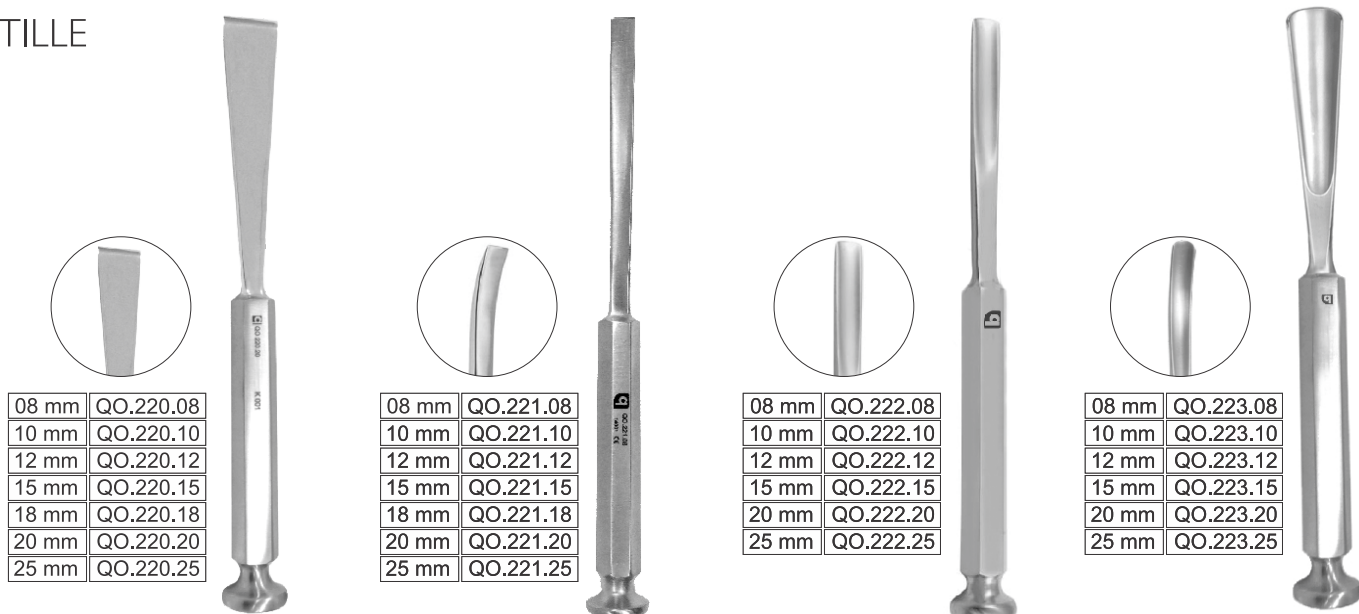

08 mm	QO.220.08
10 mm	QO.220.10
12 mm	QO.220.12
15 mm	QO.220.15
18 mm	QO.220.18
20 mm	QO.220.20
25 mm	QO.220.25

08 mm	QO.221.08
10 mm	QO.221.10
12 mm	QO.221.12
15 mm	QO.221.15
18 mm	QO.221.18
20 mm	QO.221.20
25 mm	QO.221.25

08 mm	QO.222.08
10 mm	QO.222.10
12 mm	QO.222.12
15 mm	QO.222.15
20 mm	QO.222.20
25 mm	QO.222.25

08 mm	QO.223.08
10 mm	QO.223.10
12 mm	QO.223.12
15 mm	QO.223.15
20 mm	QO.223.20
25 mm	QO.223.25

OSTEÓTOMO STILLE RETO
20 cm

OSTEÓTOMO STILLE CURVO
20 cm

OSTEÓTOMO STILLE GOIVO RETO
20 cm

OSTEÓTOMO STILLE GOIVO CURVO
20 cm

LEXER

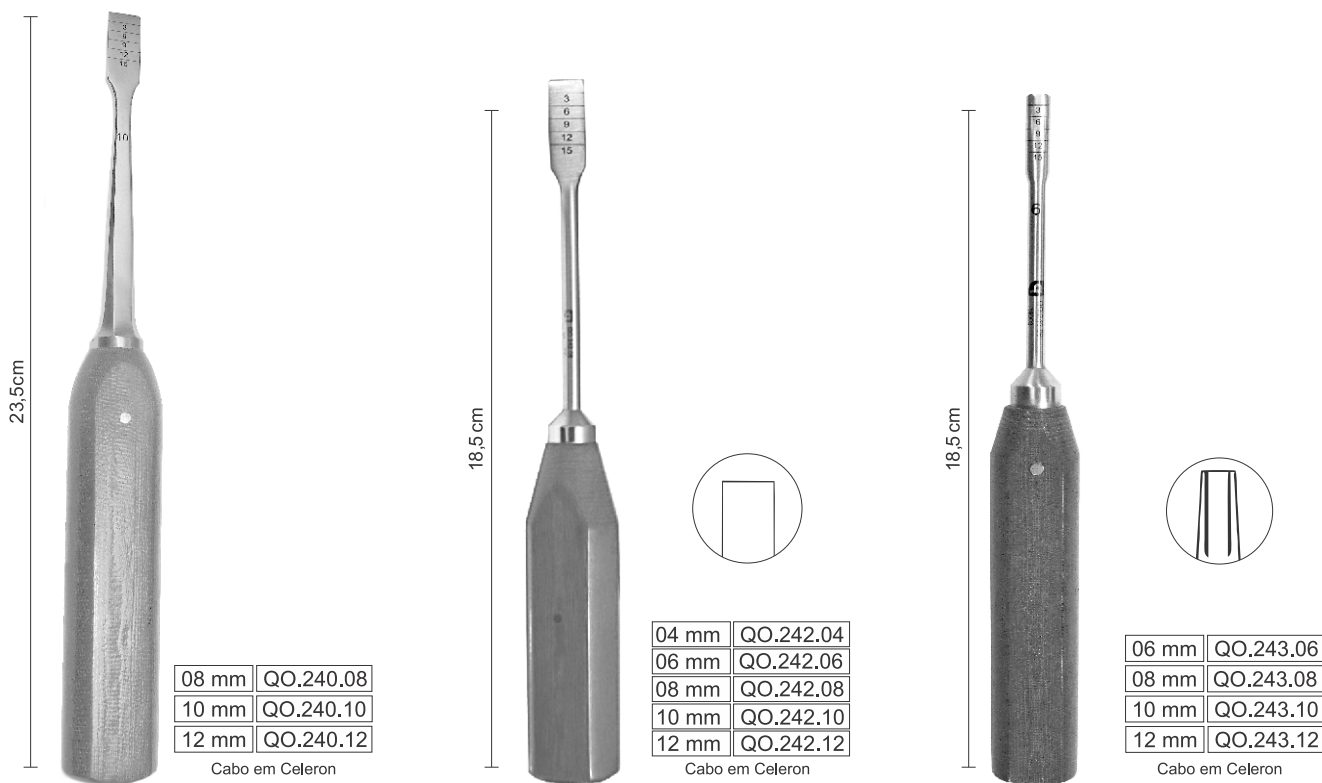

08 mm	QO.240.08
10 mm	QO.240.10
12 mm	QO.240.12

Cabo em Celeron

04 mm	QO.242.04
06 mm	QO.242.06
08 mm	QO.242.08
10 mm	QO.242.10
12 mm	QO.242.12

Cabo em Celeron

06 mm	QO.243.06
08 mm	QO.243.08
10 mm	QO.243.10
12 mm	QO.243.12

Cabo em Celeron

LEXER RETO

MINI LEXER RETO

MINI LEXER GOIVO

LAMBOTTE | FORMÃO



07 mm	QO.372.07
10 mm	QO.372.10
12 mm	QO.372.12
15 mm	QO.372.15
20 mm	QO.372.20
25 mm	QO.372.25
30 mm	QO.372.30
38 mm	QO.372.38
44 mm	QO.372.44
50 mm	QO.372.50

LAMBOTTE RETO | 24cm
Formão



07 mm	QO.374.07
10 mm	QO.374.10
12 mm	QO.374.12
15 mm	QO.374.15
20 mm	QO.374.20
25 mm	QO.374.25
30 mm	QO.374.30
38 mm	QO.374.38
44 mm	QO.374.44
50 mm	QO.374.50

LAMBOTTE CURVO | 24cm
Formão



04 mm	QO.371.04
08 mm	QO.371.08
10 mm	QO.371.10
14 mm	QO.371.14

LAMBOTTE RETO | 17cm
Formão



02 mm	QO.376.02
03 mm	QO.376.03
04 mm	QO.376.04
06 mm	QO.376.06
08 mm	QO.376.08
10 mm	QO.376.10
12 mm	QO.376.12
14 mm	QO.376.14

LAMBOTTE MINI | RETO | 12,5cm
Formão



MINI LEXER GOIVO



○	○
N° 0000	N° 000
QO.294.00	QO.294.01
2,5mm	3mm

○	○
N° 00	N° 0
QO.294.02	QO.294.03
5mm	6mm

○	○
N° 1	N° 2
QO.294.04	QO.294.05
7mm	8mm

○	○
N° 3	N° 4
QO.294.06	QO.294.07
10mm	11mm

○	○
N° 5	N° 6
QO.294.08	QO.294.09
13mm	15mm

Pontas: escala 1/1



BRUNS | 17cm



○	○
N° 0000	N° 000
QO.296.00	QO.296.01
2,5mm	3,6mm

○	○
N° 00	N° 0
QO.296.02	QO.296.03
4,4mm	5,2mm

○	○
N° 1	N° 2
QO.296.04	QO.296.05
6,8mm	8,5mm

○	○
N° 3	N° 4
QO.296.06	QO.296.07
10mm	11,5mm

○	○
N° 5	N° 6
QO.296.08	QO.296.09
13mm	14,5mm

Pontas: escala 1/1



VOLKMANN | 17cm

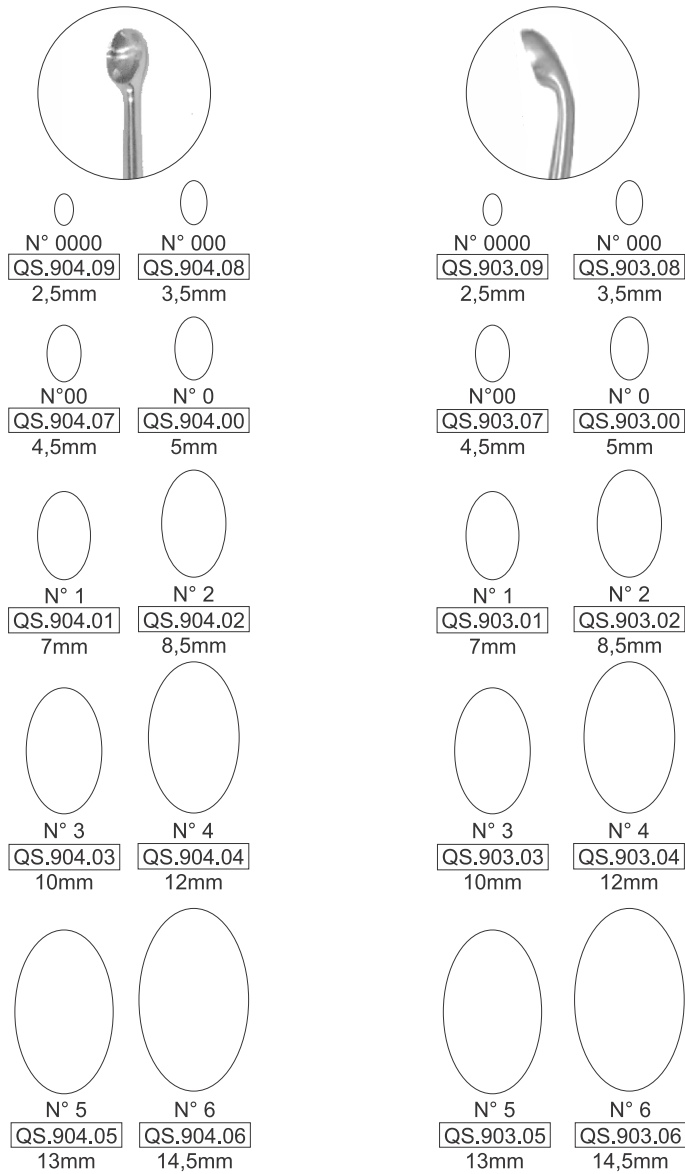

Pontas em escala 1/1

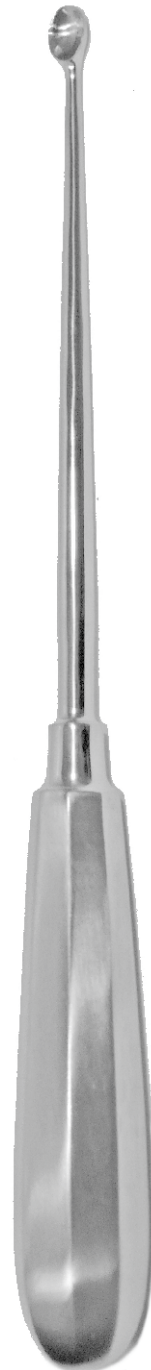

SIMON RETA | 23,5cm

SIMON ANGULADA | 23,5cm



**PINÇAS
SACABOCADO**
Ortopedia



ALVEOLÓTOMO LUER CURVO
15 cm | QD.145.15

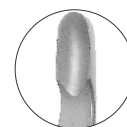

RETA
QO.846.17



CURVA
QO.847.17



PINÇA GOIVA LUER
17 cm



BEYER CURVO
17 cm | QO.879.17



RETA
QO.252.18



CURVA
QO.251.18



GOIVA LEMPERT
18 cm



PINÇA GOIVA STILLE RUSKIN CURVA
23 cm | QO.212.23

CURVA
QO.239.23

RETA
QO.238.23



GOIVA STILLE LUER
23 cm



GOIVA DUCK BILL
23 cm | QO.150.08



GOIVA RUSKIN CURVA
18 cm | QO.887.18



2mm X 10mm

GOIVA ECHLIN
23 cm | 1 mm | QO.995.00



5mm
QO.905.05

8mm
QO.905.08

GOIVA LEKSELL



PINÇAS DE REDUÇÃO

Ortopedia

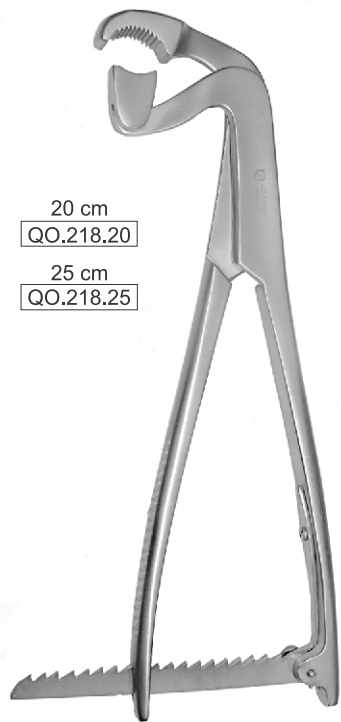

20 cm
QO.218.20

25 cm
QO.218.25

LAMBOTTE | BOCA MÓVEL



22 cm
QO.217.22

28 cm
QO.217.28

FARABEU F LAMBOTTE



22 cm
QO.216.22

28 cm
QO.216.28

FARABEU F

quinelato
instrumentos cirúrgicos



REDUÇÃO C/ CREMALHEIRA
14 cm | QO.397.14



REDUÇÃO C/ PONTA
13 cm | QO.399.13



REDUÇÃO C/ PONTA
20 cm | QO.399.20

Bone Holding Forceps
Orthopedic Surgery



LANE C / CREMALHEIRA
33 cm | QO.219.01

13 cm	QO.261.13
18 cm	QO.261.18
20 cm	QO.261.20
22 cm	QO.261.22



LOWMAN



14 cm	QO.398.14
19 cm	QO.398.19
24 cm	QO.398.24
26 cm	QO.398.26

AUTO CENTRANTE



16 cm	QO.397.16
22 cm	QO.397.22

ESPAÑHOLA

CIZALHAS
Ortopedia

Bone Cutting Forceps
Orthopedic Surgery

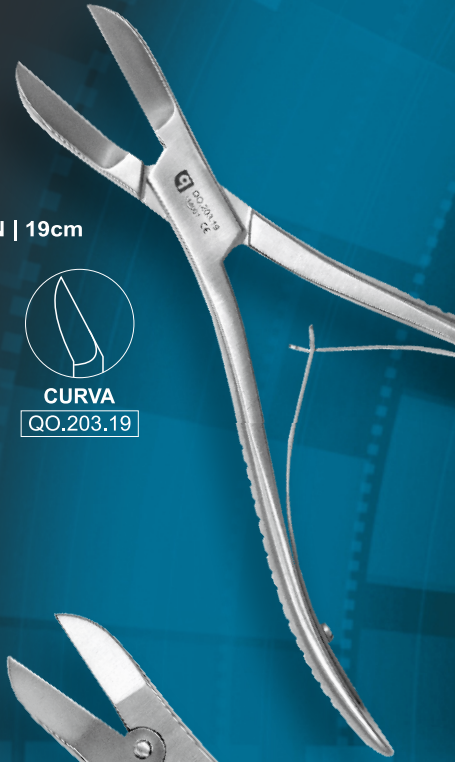

LISTON | 19cm



RETA

QO.202.19



CURVA

QO.203.19

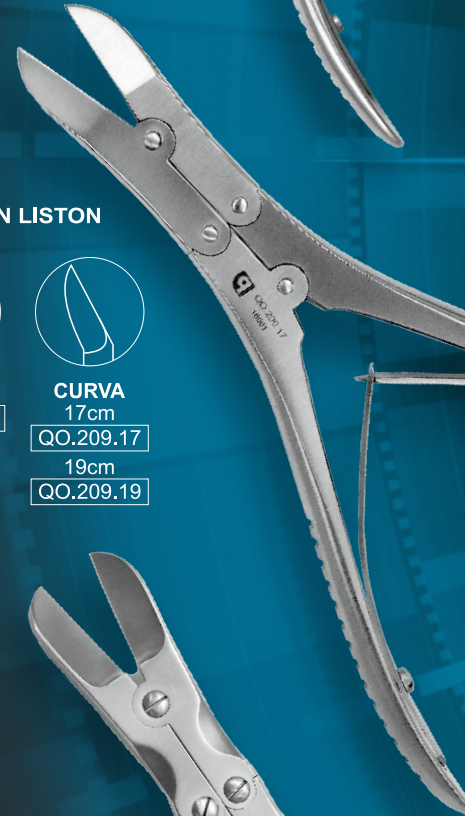

RUSKIN LISTON



RETA

QO.208.17



CURVA

17cm

QO.209.17

19cm

QO.209.19

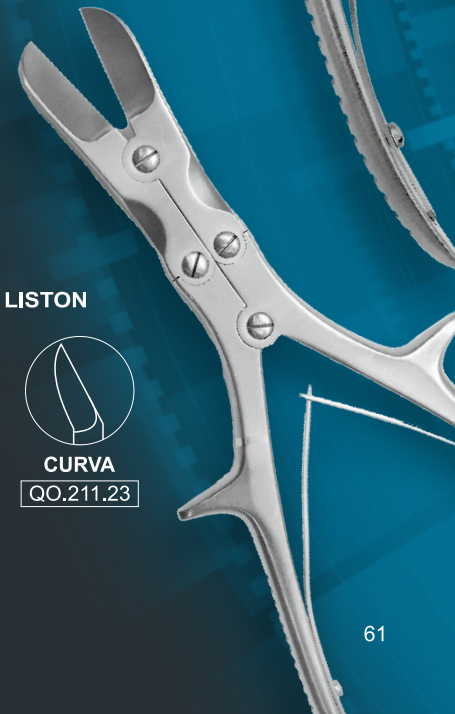

STILLE LISTON



RETA

QO.210.23



CURVA

QO.211.23

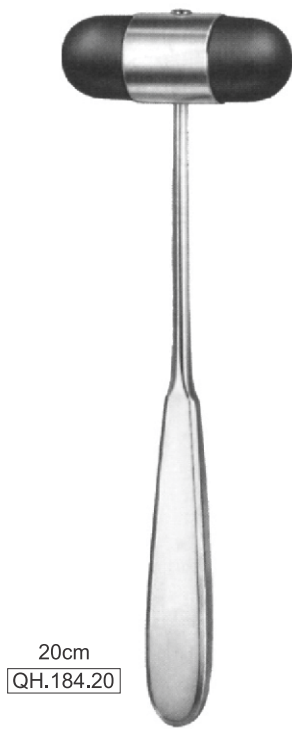

DEJERINE

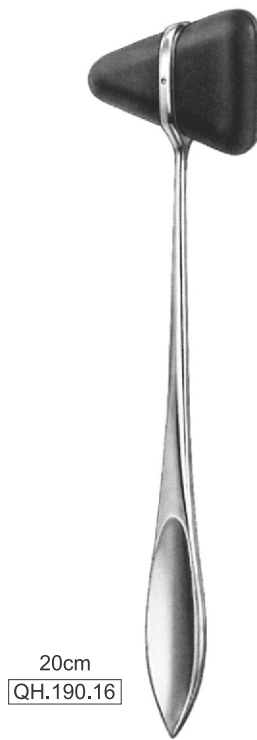

TAYLOR



MEAD

Os pesos indicados são referentes às massas dos produtos.



LUCAE

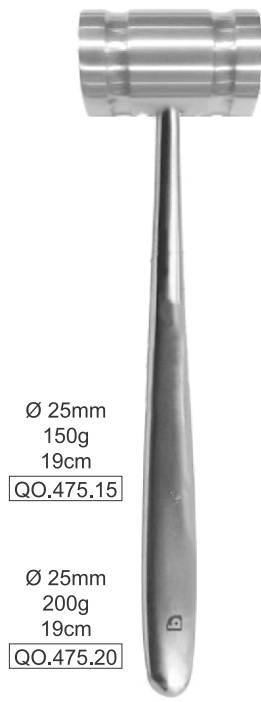

UNIVERSAL



UNIVERSAL



WILLIGER



quinelato

instrumentos cirúrgicos